

AMARNA ROYAL TOMBS PROJECT • VALLEY OF THE KINGS  
Occasional Paper No. 1

# THE BURIAL OF NEFERTITI?

*By*

Nicholas Reeves, FSA



THE BURIAL OF  
NEFERTITI?



## ABSTRACT

Recently published, high-resolution scans of the walls of room J (the Burial Chamber) of Valley of the Kings tomb KV 62 (Tutankhamun) reveal, beneath the plastered surfaces of the painted scenes, distinct linear traces. These are here mapped, discussed, and tentatively identified as the “ghosts” of two hitherto unrecognized doorways. It is argued that these doorways give access to: (1) a still unexplored storage chamber on the west of room J, seemingly contemporary with the stocking of Tutankhamun’s burial; and (2) a pre-Tutankhamun continuation of KV 62 towards the north, containing the undisturbed burial of the tomb’s original owner – Nefertiti.



*“Now, about the tomb of Nefertiti,” [Omm Sety] continued, sounding a bit hesitant. “I did once ask His Majesty where it was, and he told me. He said, ‘Why do you want to know?’ I said I would like to have it excavated, and he said, ‘No, you must not. We don’t want anything more of this family known.’ But he did tell me where it was, and I can tell you this much. It’s in the Valley of the Kings, and it’s quite near to the Tutankhamun tomb. But it’s in a place where nobody would ever think of looking for it,” she laughed. “And apparently it is still intact ...”*

– el Zeini and Dees 2007, 265-266

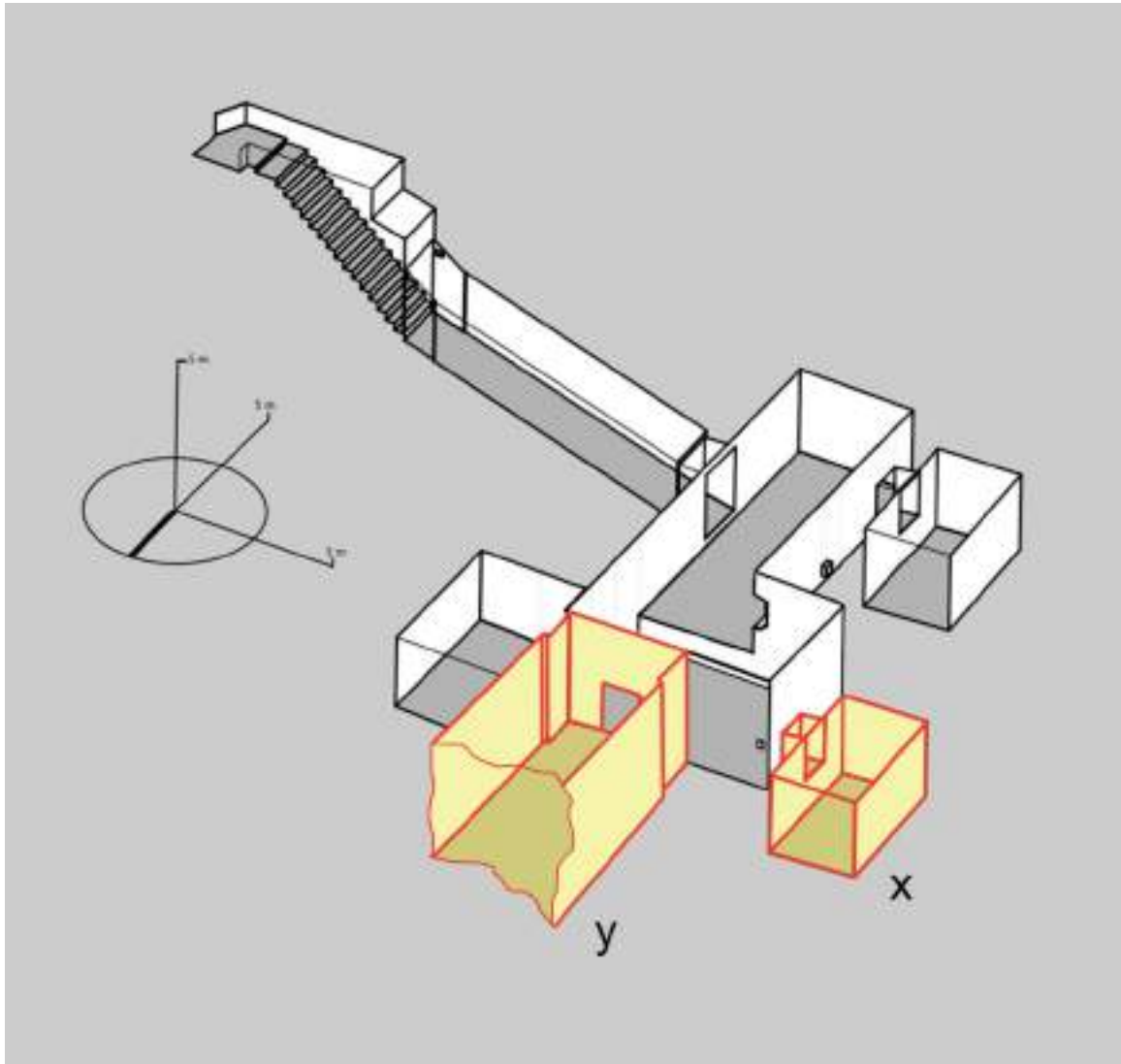

Frontispiece. The Tomb of Tutankhamun (KV 62): (x) proposed new chamber behind the decorated west wall of the Burial Chamber (J); (y) potential continuation of the tomb beyond the Burial Chamber's decorated north wall (Weeks 2003, sheet 69/70 / <http://www.thebanmappingproject.com/>, with additions, copyright © Theban Mapping Project)



AMARNA ROYAL TOMBS PROJECT • VALLEY OF THE KINGS  
Occasional Paper No. 1

# THE BURIAL OF NEFERTITI?

*By*

Nicholas Reeves, FSA



2015

A Publication of the Amarna Royal Tombs Project

Copyright © Nicholas Reeves 2015  
University of Arizona Egyptian Expedition  
1215 E. Lowell Street  
Tucson, AZ 85721-0045

[nreeves@egypt.arizona.edu](mailto:nreeves@egypt.arizona.edu)

This study is dedicated to the memory of Ruth Eldridge, MBE, who passed away peacefully on April 22, 2015, aged 93, and whose friendship over the years is here gratefully acknowledged. Whatever secrets KV 62 may still hold in store, their eventual disclosure will owe much to her far-sighted interest and generous support.



## THE BURIAL OF NEFERTITI?

Nicholas Reeves, FSA

*Amarna Royal Tombs Project, Valley of the Kings*

### INTRODUCTION

Early in 2014, Madrid-based art-replication specialists Factum Arte took the significant step of publishing online the data<sup>1</sup> on which a critical element of their facsimile of the tomb of Tutankhamun<sup>2</sup> – since opened on a site adjacent to the Luxor (west bank) house of Howard Carter<sup>3</sup> – would in large part be based. The content of this public release was unprecedented: high-definition colour photography of the painted

scenes of the KV 62 Burial Chamber<sup>4</sup> (J)<sup>5</sup> (captured 1:1 at 600-800 DPI), accompanied by a scanned record of the surfaces of the walls which carry this decoration (at a resolution of between 100 and 700 microns)<sup>6</sup> (Fig. 1). Both resources boast an impressive zoom capability, and as a contribution to the on-going documentation of Tutankhamun's tomb their importance cannot be overstated. For Egyptologists the data provide immediate, desk-based access to the smallest iconographic detail and brushstroke of the KV 62 scenes, while conservators anywhere in the world are now able with ease to scrutinize and consider the paintings' every crack, blemish, and technical feature.

For the archaeologist these files possess a further potential to be investigated here: namely, what they might be coaxed to reveal about the architecture of the tomb beneath this decoration. The short answer seems to be: a great deal.

Cautious evaluation of the Factum Arte scans over the course of several months has yielded results which are beyond intriguing: indications of two previously unknown doorways, one set within a larger partition wall and both seemingly untouched since antiquity. The implications are extraordinary: for, if digital appearance translates into physical reality, it seems we are now faced not merely with the prospect of a new, Tutankhamun-era storeroom to the west; to the north appears to be signalled a continuation of tomb KV 62,

---

Version 1.3, July 23, 2015

Copyright © Nicholas Reeves 2015

\* The research on which this study is based was initiated in February 2014, towards the end of my tenure as Lila Acheson Wallace Associate Curator of Egyptian Art at The Metropolitan Museum of Art; the paper was completed in July 2015 as University Indian Ruins Visiting Scholar at the School of Anthropology, University of Arizona. To each of these institutions and their staffs I extend my sincere thanks. For helpful discussions around the paper's theme I am indebted to Dieter Arnold, Pearce Paul Creasman, Noreen Doyle, Yumiko Ueno, Richard H. Wilkinson, and Kei Yamamoto. For other significant contributions I am grateful to David Bowker, Douglas Curtis, †Ruth Eldridge, Dunja Hersak, Adam Lowe, Stephen Pollard, Timothy Potts, Jon Scoones, Cat Warsi, and Kent Weeks. It goes without saying that responsibility for any errors of fact or interpretation is mine alone.

<sup>1</sup> <http://www.factumfoundation.org/pag/210/High-Resolution-Image-Viewer>; <http://www.highres.factum-arte.org/Tutankhamun/> (accessed July 16, 2015). Since the quality is significantly higher than that of the images reproduced in this report, for detailed examination of the Factum Arte scans the reader is referred online.

<sup>2</sup> Factum Arte 2012.

<sup>3</sup> For a report, see [Forbes] 2013.

---

<sup>4</sup> Previous surveys of these scenes have included Steindorff 1938, and Johnson 1993-1994.

<sup>5</sup> Room designations throughout this paper follow those of Weeks 2003, online at <http://www.thebanmappingproject.com> (accessed July 16, 2015).

<sup>6</sup> It may be noted that those portions of the south wall decoration removed by Carter at the time of his clearance – see below, n. 21 – are not currently included in the Factum Arte online documentation.

and within these uncharted depths an earlier royal interment – that of Nefertiti herself, celebrated consort, co-regent, and eventual successor of pharaoh Akhenaten.

In the pages which follow I set out my arguments in support of this evaluation: in Part One I summarize the current understanding of KV 62 in the light of recent developments in late- and post-Amarna history and archaeology; in Part Two I present the Factum Arte scans and a considered assessment of these in the context of other, independent features which both support and clarify my analysis.

*Prima facie* the case is compelling. It goes without saying, however, that a final determination on the presence – or otherwise – of additional elements within KV 62, and their precise character, will be made only on the ground. Obviously a full and detailed geophysical survey of this famous tomb and its surrounding area is now called for – and I would suggest as one of Egyptology’s highest priorities.

## PART ONE: THE TOMB AND THE HISTORICAL SITUATION

The tomb of Tutankhamun<sup>7</sup> (Fig. 2) is that now numbered KV 62 in the Valley of the Kings, located in the central area of that cemetery’s principal wadi in close proximity to other deposits variously associated with the late- and post-Amarna periods (ca. 1340-1320 BC). These finds comprise: the corridor tomb KV 16 (ultimately employed by Ramesses I);<sup>8</sup> the unfinished corridor tomb KV 55 (originally employed for the reinterment of Tiye, mother of Akhenaten, to which the burial of Akhenaten was added *temp.* Tutankhamun; the bulk of Tiye’s burial, including her body, seems to have been removed *temp.* Ramesses IX);<sup>9</sup> the shaft tomb KV 56 (original queenly

ownership uncertain);<sup>10</sup> the extensive, kingly corridor tomb KV 57 (ultimately employed by Horemheb);<sup>11</sup> and the shaft tomb KV 58 (original ownership uncertain).<sup>12</sup> A storage pit and a further single-chambered shaft associated with these or other burials of the period are, respectively: KV 54 (containing materials seemingly displaced in antiquity from KV 62);<sup>13</sup> and the recently discovered and as yet only partially published funerary storeroom KV 63 (*temp.* Tutankhamun).<sup>14</sup> For the relative locations of these finds, see Fig. 3.

---

<http://www.thebanmappingproject.com> (accessed July 16, 2015).

<sup>10</sup> Reeves 1990a, 131-133 and 136-137; Reeves and Wilkinson 1996, 153; Reeves 2003, 69-70; Weeks 2003, sheet 65/70, and online at <http://www.thebanmappingproject.com> (accessed July 16, 2015). Cf. Reeves 2001b.

<sup>11</sup> Reeves 1990a, 75-79 and 88-90; Reeves and Wilkinson 1996, 130-133; Weeks 2003, sheets 66-67/70, online at <http://www.thebanmappingproject.com> (accessed July 16, 2015). The plan of KV 57 picks up on an interesting feature in the tomb of Amenhotep III (WV 22) – what I have elsewhere (Reeves 2003, 69-71) described as a subsidiary “queen’s suite” (Jc-Jcc-Jccc). Room Jc within KV 57 is the only (known) chamber in the Valley of the Kings of appropriate size and potential date to have accommodated in their correct orientation (Bell 1990) the large gilded shrines eventually employed for the burial of Tutankhamun (Piankoff 1951) (which appear, in fact, to represent a mixed set drawn from two separate burial equipments: that of Akhenaten [shrine II?], and that of his co-regent, Neferneferuaten [I (outermost)?, III and IV]). (Note that Carter numbered the Tutankhamun shrines from the outside in – i.e. in the order in which he encountered them.) For this re-use see further below. The shrines’ possible intended destination, combined with the fact that the wall decorations of KV 57 were laid out according to an Amarna-style, 20-square grid (Robins 1983a), suggests at least the possibility that KV 57 may have originally been cut for Amenhotep IV-Akhenaten and later planned as (if not realized for) the immediate post-Amarna burials of Akhenaten and Neferneferuaten.

<sup>12</sup> Reeves 1981b; Reeves 1982a; Reeves 1990a, 72-75 and 87-88; Reeves and Wilkinson 1996, 186; Weeks 2003, sheet 68/70, online at <http://www.thebanmappingproject.com> (accessed July 16, 2015).

<sup>13</sup> Reeves 1990a, 69-70 and 86; Reeves 1990b, 38-39 – in both of which I proposed as the original place of deposition the KV 62 entrance corridor (B). For the pit’s plan and section see Weeks 2003, sheets 66-63/70, online at <http://www.thebanmappingproject.com> (accessed July 16, 2015). For its contents see Winlock 1941 and, revisited, Arnold 2010.

<sup>14</sup> For the scattered bibliography to date see <http://www.kv-63.com/publications.html> (accessed July 16, 2015). The presence within KV 63 of several empty coffins is suggestive of a transfer of Amarna mummies for reburial in the Valley of the Kings – to judge from the small

---

<sup>7</sup> The literature is immense: for a recent bibliography see Wong 2013. For the plan, see Weeks 2003, sheet 69/70, and online at <http://www.thebanmappingproject.com> (accessed July 16, 2015).

<sup>8</sup> Reeves 1990a, 91-92 and 99; Reeves and Wilkinson 1996, 134-135. For the plan, see Weeks 2003, sheet 33/70, and online at <http://www.thebanmappingproject.com> (accessed July 16, 2015). The tomb is included here solely on the basis of its employment in the layout of the painted decoration of a 20-square (Amarna) grid – for which see Robins 1983b.

<sup>9</sup> Reeves 1981a, to be read in conjunction with Reeves 1982b; Reeves 1990a, 42-49 and 55-60; Reeves 1990c, xii-xiv; Reeves and Wilkinson 1996, 117-121 – my opinions now modified to regard Akhenaten’s presence within KV 55 as a primary interment rather than as a burial transferred from el-Amarna: see Reeves in press a. For the plan, see Weeks 2003, sheet 64/70, and online at

The entrance to KV 62<sup>15</sup> consists of a staircase (A) leading down to a sloping corridor (B) which, when first entered in 1922, preserved intact at either end its original, (partially re-)closed,<sup>16</sup> (re-)plastered and (re-)sealed blockings (Carter nos. 004 and 013).<sup>17</sup> Oriented towards the west, corridor B drops down to access, first, a transverse chamber (the Antechamber, I) and, beyond that, a single, sunken storeroom (the Annexe, Ia) – this latter entered via a small, rectangular doorway cut in the rock at the south end of the Antechamber’s west wall, again originally closed off, plastered, and stamped over with large seals (Carter no. 171).

To the north of the Antechamber, and similarly dug to a lower level, lies Tutankhamun’s Burial Chamber (J) – at the time of the tomb’s discovery a space separated from the Antechamber by a plastered, dry-stone partition pierced by an internal doorway to permit continuing access; following the king’s burial this internal doorway had itself been blocked with rough stones, plastered, and again stamped over its entire surface with large seals (Carter no. 028). At the far end of the Burial Chamber, on its east, stands a further doorway, never closed, which gives admittance to a second storage chamber (the Treasury, Ja).

As has long been recognized, KV 62’s restricted size is less than appropriate for a king’s burial of the Eighteenth Dynasty. The common (though, as I shall argue, mistaken) consensus is that the sepulchre had been selectively enlarged and adapted for

Tutankhamun’s use from a much smaller tomb originally intended for a private individual.<sup>18</sup>

Only one of KV 62’s current suite of four rooms had ever been plastered and painted and that was the Burial Chamber (J), or “House of Gold” (*pr-nbw*) – the ancient terminology clearly referencing this decoration’s conspicuous yellow ground.<sup>19</sup> The paintings within this room document the principal stages in Tutankhamun’s physical and spiritual transition from this world to the realm of the gods.

Although affected by serious mould growth,<sup>20</sup> these painted surfaces remain both sound and intact.<sup>21</sup> Covering as they do virtually every inch of the walls, the underlying architecture is almost wholly obscured. Carter, followed by all Egyptologists since, seems to have accepted that beneath lay only bedrock, influenced in this understanding by the fact that four eccentrically placed amulet emplacements (Carter nos. 257-260) cut through the decoration to expose solid limestone (Fig. 4).<sup>22</sup>

In contrast to the modest scale and simplicity of the tomb proper, the range, quality, and richness of the furnishings crammed into Tutankhamun’s four small chambers were overwhelming.<sup>23</sup> While the majority of Egyptologists have tended to take this material at face value, those looking more critically have observed the

---

seal impressions so far announced, carried out contemporaneously with activities within KV 55 and KV 62 during or immediately after the reign of Tutankhamun. As I suggest elsewhere (Reeves in press a), one of the items recovered from KV 63 – a dismantled framework “bier” (Ertman 2009) – may have had a role in the Opening of the Mouth ceremony of an Egyptian royal of this period.

<sup>15</sup> Cf. Griffith Institute, Carter MSS, I.3.31 for a discussion of the tomb’s component parts, and see below, n. 44. For the excavator’s Griffith Institute archive relating to the Tutankhamun clearance (including Harry Burton photographs), see online at <http://www.griffith.ox.ac.uk/discoveringTut/> (accessed July 16, 2015).

<sup>16</sup> Tutankhamun’s tomb had in fact been entered by robbers at least twice in antiquity: Reeves 1990a, 61-69 and 80-85; Reeves 1990b, 95-97. The plundering appears to have been superficial, and confined to items easily to hand; the inner shrines, sarcophagus and nested coffins of the king had not been penetrated.

<sup>17</sup> For the excavation cards these Carter numbers refer to see online at <http://www.griffith.ox.ac.uk/discoveringTut/> (accessed July 16, 2015).

---

<sup>18</sup> Recently restated, for example, by Eaton-Krauss 2009-10, 38-39.

<sup>19</sup> Carter and Gardiner 1917; Černý 1973, 29-30. Černý chose to associate the designation “House of Gold” with the large shrines of gilded wood surrounding the sarcophagus. In the Ramesses IV tomb plan a nest of five such shrines is shown, together with the framework for a funerary pall erected between shrines four and five (outermost); Tutankhamun’s tomb, however, contained only four shrines + pall framework between shrines three and four (outermost) – employing Carter’s numbering, between shrines I (outermost) and II. The explanation for this difference in quantity probably lies in the fact that (the larger proportion of) Tutankhamun’s shrines had originally been prepared for an individual of (junior) co-regent status (for which see n. 11 above, and further below).

<sup>20</sup> Most recently Wong et al. 2012, S323-S324.

<sup>21</sup> The entire south wall decoration remained intact until this artificial blocking on which it had in part been executed was dismantled by Carter to facilitate the extraction of the large funerary shrines erected around the royal sarcophagus. See Reeves 1990b, 73-74.

<sup>22</sup> The amulets themselves had been installed at a later stage of the funeral proceedings, after which the emplacements were closed off with splinters of limestone mortared in place and finally painted over in a slightly different shade of yellow. See Carter no. 257 = Burton photo p0879a (opened) (east); Carter no. 258 = Burton photo p0879 (west); Carter no. 260 = Burton photo p0879b (south); Carter no. 259 = Burton photo p0879c (north).

<sup>23</sup> For a basic listing of the contents, see Murray and Nuttall 1963, and the survey in Reeves 1990b.

presence of a range of objects taken over from predecessor kings and adapted for Tutankhamun's use.<sup>24</sup> It transpires that the extent of this recycling is far greater than previously recognized,<sup>25</sup> with direct or indirect evidence of re-use now detected in an astonishing 80% or more of the tomb's core burial equipment (to include the large gilded shrines, sarcophagus, coffins, gold mask, and canopic equipment). Originally produced several years before Tutankhamun's accession, during the reign of Akhenaten, this material falls into two distinct groups: (1) a stray scattering of pieces seemingly once intended for the burial of Akhenaten himself;<sup>26</sup> and (2), by far the larger proportion, items initially prepared for the use of Akhenaten's junior co-regent – that mysterious and much-discussed individual distinguished by the cartouched names Ankhkheperure (+ epithet) Neferneferuaten (+ epithet).<sup>27</sup>

These objects provide a remarkable insight into the crisis generated by Tutankhamun's early and unexpected death. With funerary preparations for the boy king not yet set in train, the ancient undertakers were clearly obliged to improvise: whatever lay conveniently to hand in the Valley of the Kings and unused in palace stores was seized upon, adapted, and pressed into service – with the final result, in terms of both tomb and treasure, falling considerably short of the pharaonic norm.<sup>28</sup>

<sup>24</sup> See particularly Engelbach 1940; Harris 1992; Eaton-Krauss 1993, 1994, 1998; Gabolde 1998; Reeves 2014 (Hammond 2014); Reeves in press a.

<sup>25</sup> Reeves 2011; Reeves in press a.

<sup>26</sup> Harris 1992.

<sup>27</sup> Ibid. The presence and nature of these epithets is significant, and in the case of the prenomen, Ankhkheperure serve to distinguish texts relating to this co-regent from those of the full pharaoh Ankhkheperure Smenkhkare-djeserkheperu. The different name-forms (prenomen : nomen) employed by the co-regent Neferneferuaten (epithets italicized), in likely chronological order, are:

(a) Ankhkheperure-*beloved of Neferkheperure* [= Akhenaten] : Neferneferuaten-*beloved of Waenre* [= Akhenaten]

(b) Ankhkheperure-*beloved of Neferkheperure* (or, *beloved of Waenre*) [= Akhenaten] : Neferneferuaten-*she who is beneficial for her husband* [= Akhenaten]

(c) Ankhkheperure-*beloved of the Aten* [= Akhenaten] : Neferneferuaten-*the ruler*

(d) Ankhkheperure : Meryaten (lit. *Beloved of the Aten* [= Akhenaten])

The co-regent's sex is clearly established as female (see further below, n. 31) and, as the epithets imply, her status wholly dependent on Akhenaten.

<sup>28</sup> Our understanding of a "standard" pharaonic tomb at this period is compromised by the fact that the more significant burials in the Valley had been officially stripped of their valuables at the end of the New Kingdom (ca. 1000 BC) (Reeves 1990a, 276) – a process from which generally only

Close study of this repurposed equipment sheds light too on the identity of its obscure co-regent owner. Body shape,<sup>29</sup> iconography,<sup>30</sup> and inscriptions<sup>31</sup> combine to identify Ankhkheperure (+ epithet) Neferneferuaten (+ epithet) as a woman, and most likely the great royal wife Neferneferuaten-Nefertiti in newly elevated guise.<sup>32</sup> This same lady's rise evidently continued, culminating in her appointment as sole pharaoh following Akhenaten's death and the adoption of a new and developed form of her semi-regal name – Ankhkheperure Smenkhkare-djeserkheperu.<sup>33</sup>

---

the Amarna dead appear to have escaped thanks to the Nineteenth Dynasty removal of their names from cemetery records (Reeves in press a). From the physical size and splendour of these kings' tombs, however, it is difficult to believe that their contents were not significantly richer than that of Tutankhamun – which, as the iconography of specific pieces reveals (Reeves in press a), as items intended for a female co-regent in fact fall somewhere between that of a queen and a full pharaoh.

<sup>29</sup> For example, Carter nos. 289b (figure with breasts, standing on the back of a leopard); 458 (*shawabti*). See Reeves 1990b, 131, bottom left, and 138, middle, far right.

<sup>30</sup> For example, Carter obj. no. 254 (Tutankhamun's second coffin); 266g(1-4) (canopic coffinettes). See Reeves 2011; Reeves in press a.

<sup>31</sup> The female sex of Akhenaten's co-regent was first demonstrated textually by Julia Samson from the occasional inclusion in the prenomen of faience ring bezels of the feminine marker, *t* – Ankhkheperure (+ epithet). See for details Harris 1992; Gabolde 1998, 147-185.

<sup>32</sup> See Reeves 2001a, 172-173; Reeves 2011; Reeves in press a; Dodson 2009, 38. I had originally dated this elevation as co-regent to around Year 12 of Akhenaten's reign; the recent discovery of a graffito dated Year 16, however, in which Nefertiti is referred to still as great royal wife, presumably indicates it was later (Van der Perre 2014). Nefertiti is the only candidate for whom a consistent progression in status may from the very start be discerned – in her queenly names (early evolving from simple "Nefertiti" to the more elaborate "Neferneferuaten-Nefertiti" – which addition of course anticipates the future co-regent's nomen), but also in her queenly titulary (developing from the regular *hmt nsw wrt* to the still obscure but evidently superior *hmt nsw ʕt* – Reeves 1978). Other Egyptologists, accepting as an actual name (rather than as an epithet) the (d) nomen (n. 27 above) and sundry references in the Amarna Letters, prefer to identify the co-regent Neferneferuaten with Akhenaten's eldest daughter, Meritaten (e.g. Allen 2009; Gabolde 2009; von Falck 2012) – notwithstanding that both Neferneferuaten and Meritaten are mentioned together, and as distinct entities, in one of the key pieces of evidence from the period (Carter obj. no. 001k, Burton photo p0478; Beinlich and Saleh 1989, 4).

<sup>33</sup> The idea goes back to Harris 1973 (though his opinions have since changed: Harris 2008). See more recently Reeves 2001a, 172-173, and Reeves 2014 – with the alterations to the famous "Golden Throne" (Carter object no. 091) now revealing a clear sequence of inscriptional re-use from Akhenaten through Neferneferuaten to Smenkhkare and



It was presumably at this point, as full king, that Nefertiti's now outmoded co-regent's tomb furnishings were set aside – we may assume in favour of something very much better and of fully pharaonic design.<sup>34</sup> To date, however, not a scrap of this actual burial (rather than materials from one or other of Nefertiti's earlier, planned interments)<sup>35</sup> has ever been brought to light. That her ultimate resting place was at Thebes,<sup>36</sup> under the name of Smenkhkare, I believe is now virtually certain, with a strong presumption that

---

Tutankhaten/amun (on which discovery see for the present Hammond 2014). I do not subscribe to the view which posits the existence of two regal entities sharing the *Ankhkheperure* prenomem – namely, an (earlier) male Ankhkheperure Smenkhkare-djeserkheperu and a (later) female Ankh(et)kheperure + epithet Neferneferuaten + epithet (Hornung 2006, 207) – not least because both “individuals,” besides sharing virtually the same prenomem, are found associated with the same great royal wife, Meritaten (as great royal wife of Neferneferuaten – Carter obj. no. 001k, Burton photo p0478; as great royal wife of Smenkhkare – Beinlich and Saleh 1989, 4; Davies 1905, pl. XLI).

<sup>34</sup> Given the probability that the reign of Smenkhkare was exceptionally short, being brought to a swift (and unhappy) end following her appeal to the king of the Hittites for a son to occupy the throne of Egypt by her side (for the claims of Nefertiti, as opposed to those of Tutankhamun's widow, Ankhesenamun, see J.R. Harris in Reeves 2001a, 176-177; Miller 2007), it is likely that the obsequies of two full pharaohs, Akhenaten and Smenkhkare, in the end fell to Tutankhamun's responsibility. If so, then Smenkhkare as the immediate predecessor and the direct source of Tutankhamun's legitimacy (Revez 2010; Helck 1984, 2031, 6-7) will presumably have taken precedence; despite the Hittite “betrayal,” given her efforts when alive at accommodating the Amun priesthood Nefertiti will also have wielded the greater influence, at least at Thebes. Under such circumstances it would seem to me not improbable that, too senior to employ her existing and only “semi-pharaonic” (Reeves in press a) co-regent's funerary equipment, Nefertiti was in the end assigned Akhenaten's own burial furniture, suitably re-inscribed (see below). This prioritizing of claims would explain the (literally) care-less interment of Akhenaten within the Valley tomb of his mother, Tiye (KV 55), contained in a hastily adapted coffin originally prepared for his secondary wife Kiya and accompanied by four canopic jars appropriated from this same woman: not only was Akhenaten seriously unpopular, but his post-mortem approbation was for Tutankhamun an irrelevance.

<sup>35</sup> I.e. the *shawabti* prepared for, but not actually employed in, the el-Amarna burial of Nefertiti as great royal wife (Loeben 1986; Loeben 1999); and of course the Neferneferuaten equipment adapted for Tutankhamun (above, and Reeves in press a).

<sup>36</sup> Theban mortuary temple of (pharaoh) Ankhkheperure is mentioned in the well-known Pere graffito: Gardiner 1928, 11, pl. VI, 1.33.

the burial remains hidden.<sup>37</sup> Now, for the first time, we may be in a position to speculate precisely where.

## PART TWO: THE BURIAL CHAMBER SCANS AND THEIR INTERPRETATION

Two of the four Factum Arte scans – those of the west and north walls – shed significant new light on KV 62 and its development.

### (a) West Wall

The west wall of Tutankhamun's Burial Chamber (J) is that decorated with the twelve apes of the first hour of the Book of the Hidden Chamber, or Amduat.<sup>38</sup> The painted surface of this wall is here reproduced as Fig. 5, with my annotated version of Factum Arte's scan of the surface shown in both positive and negative views as Figs. 6 and 7. For greater detail the reader is referred to the high-resolution images posted online.<sup>39</sup>

Close examination of these surface scans reveals, beneath the plaster, several features in shallow relief.<sup>40</sup> These traces are here assigned the reference numbers 1-4. The first, no. 1, located to the immediate right of the amuletic niche (Carter no. 258), runs the full height of the wall; no. 2 proceeds upwards at an angle of 90 degrees to the floor, stopping at a level of just over one third of the wall's height; feature 3 runs from the ceiling down, stopping at a point adjacent to no. 2; while the travel of feature no. 4 essentially mimics that of no. 2.

The impression conveyed by their somewhat “frayed” appearance and slightly angled course is that nos. 1 and 3 represent natural faults in the rock analogous to that observed by Carter running across the Antechamber and Burial Chamber ceilings (see below). The blurred verticals 2 and 4 bring to mind something quite different, however, and that is artificially defined edges – specifically, from their matched heights, the twin jambs of a doorframe. Interestingly, this interpretation is reinforced by the abrupt disappearance of feature nos. 2, 3 and 4 at precisely the same horizon. This disappearance arguably serves: (1) to locate the putative doorway's rock-cut lintel; and (2) to confirm that the living rock

---

<sup>37</sup> Cf. Reeves and Wilkinson 1996, 126; Reeves 2002a.

<sup>38</sup> Hornung 1999a, 34; Hornung 1963, I, 4-22, II, 9-41; cf. Robins 2007, 327-328.

<sup>39</sup> <http://www.highres.factum-arte.org/Tutankhamun/> (accessed July 16, 2015).

<sup>40</sup> The short painted vertical and longer, broken horizontals located between nos. 3 and 2/4 in Figs. 6-7 are merely bleed-throughs of the overlying painted decoration, and without significance.

between 2 and 4, through which the no. 3 fault formerly continued, had been physically removed and replaced with an artificial blocking (cf. Fig. 8).<sup>41</sup>

As fanciful as this assessment may seem, it is in fact supported by several independent pieces of evidence.

First, meaningful parallels to this specific combination of traces may be cited from elsewhere in the Valley of the Kings. Two identical, but exposed, instances of neatly cut jambs and curtailed, supra-lintel fault are shown in Fig. 9: left, above the entrance to the Treasury doorway (Ja) within the tomb of Tutankhamun; and right, above and defining the entrance to room Jbb in the tomb of Amenhotep III (WV 22). Closed up and finally plastered over, it is apparent that both voids would have presented “ghosts” identical to those now discerned beneath the painted surface of Tutankhamun’s west wall.

Secondly, the putative doorway these west wall traces delineate turns out to be identical in size to that adjacent doorway to the south connecting the KV 62 Antechamber (I) with its Annexe (Ia) (Figs. 10-11).<sup>42</sup> Since the odds against this being mere coincidence are surely high, the inference must be that the perceived new blocking is indeed real and that it and its fellow are contemporaneous, cut during the same phase of the tomb’s development.

Thirdly, that particular phase of development will almost certainly have been the adaptation of KV 62 for Tutankhamun’s regal use.<sup>43</sup> Although the final layout of the young king’s four-chambered tomb is usually considered somewhat arbitrary, a sketch now preserved among Carter’s papers in the Griffith Institute, Oxford (Fig. 12, left) reveals that, within the limitations imposed by KV 62’s underlying plan (see below), the ancient architect’s adaptation had been both deliberate and rational.<sup>44</sup> With a notional 90 degree, counter-clockwise turn of the tomb’s

Antechamber, Annexe, Burial Chamber, and Treasury, Carter was able to show that KV 62 in fact incorporates all of the key features of a full-sized Eighteenth Dynasty royal tomb: burial chamber (I), crypt (J), and satellite storerooms (Fig. 12, right). The sole substantive difference between Carter’s “corrected” plan and that of a standard royal sepulchre lies in the number of Tutankhamun’s orbital storerooms. At this period the regular count is four, arranged at 2, 4, 8 and 10 o’clock. KV 62, by contrast, displays only two such satellites – a “2 o’clock” (the Treasury, Ja) and an “8 o’clock” (the Annexe, Ia), with two further side rooms clearly missing from the plan as we currently have it. Of these absences, since Tutankhamun’s tomb turns decisively to the right (a feature considered further below), obviously a “4 o’clock” chamber can never have been present since its designated position is that now occupied by the tomb’s entrance corridor (B).<sup>45</sup> The position of the missing “10 o’clock” side-room, however, corresponds precisely with that of the doorway now discerned beneath the decoration of Tutankhamun’s west wall (Fig. 13).

The traditional function of such orbital side rooms was storage,<sup>46</sup> but it is worth pointing out that occasionally these treasuries were adapted and enlarged to take on a different role. For example, the situation of the proposed new KV 62 doorway, close to the head-end of Tutankhamun’s sarcophagus, is identical to that of the secondary “queen’s suite”<sup>47</sup> Jb-Jbb in the tomb of Amenhotep III (WV 22). Though initially cut for regular storage, the WV 22 parallel had been visibly enlarged during its lifetime<sup>48</sup> with the evident intention of receiving an interment – that of Sitamun, Amenhotep III’s daughter and later great royal wife.<sup>49</sup> Theoretically, therefore, a “10 o’clock”

<sup>41</sup> Comparable to others in the tomb: cf. Carter card nos. 004, 013, 028, and 171.

<sup>42</sup> Carter (and Mace) 1923-1933, III, 100, describes the Annexe doorway (the lower portion of which had been broken through in antiquity and never made good) as 51 inches (145 cm) high by 37 inches (94 cm) wide, “blocked up with rough splinters of limestone and ... plastered over on the outside. The plaster, while still wet, had received numerous impressions of four different sepulchral-seals of the king”. No evidence of any stamped seals may be detected beneath the decoration of the west or north walls, the concealing paintings themselves presumably (and correctly) considered security enough. Carter’s measurement of the Annexe itself was 14 feet (4.27 m) long, 8 feet 6 inches (2.59 m) wide, and 8 feet 5 inches (2.57 m) high (ibid., 100-101).

<sup>43</sup> And see below, n. 61.

<sup>44</sup> For the Carter sketch see Reeves 1990b, 70 (my Fig. 12, left). The adaptation of KV 62 for royal use is discussed in Carter (and Mace) 1923-1933, III, v-viii.

<sup>45</sup> Unless, that is, a fourth side-room was provided elsewhere within the tomb. The sole possible option is again concealment beneath the Burial Chamber’s painted decoration – though from the Factum Arte surface scans I have been unable to detect obvious indications. The anomalous greater height of the magical niche Carter no. 258 – cut into the solid portion of the south wall (165 cm from the floor, as opposed to a height-range of between 120-130 cm for its fellows: cf. Fig. 1) – might, however, be suggestive, since it is sufficiently elevated to accommodate beneath another doorway similar in height to that leading from the Antechamber into the Annexe (I-Ia). The close proximity of this southern niche to the west wall, however, could be seen to lessen this possibility.

<sup>46</sup> Cf. Carter MSS, Griffith Institute, I.A.272 ff.

<sup>47</sup> A similar suite may be observed in the tomb of Horemheb (KV 57): see above, n. 11.

<sup>48</sup> Kondo 1995, 30.

<sup>49</sup> Hayes 1935, 29; Reeves 2003, 69-71. Amenhotep III’s senior great royal wife, Tiye, appears to have been intended for burial within Amenhotep III’s principal “queen’s suite”,

chamber within KV 62 might have been employed in a similar manner – that is, to accommodate the burial, or burials, of additional member(s) of the (Amarna) royal family.<sup>50</sup>

(b) North Wall

The longer, north wall of Tutankhamun's Burial Chamber carries a painted decoration incorporating three separate scenes. As now labelled, these depict, from right to left: (1) the Opening of the Mouth of Tutankhamun's mummy by the God's Father Ay; (2) Tutankhamun welcomed into the Underworld by the goddess Nut; and (3) Tutankhamun, accompanied by his *ka*, embraced by the god Osiris.<sup>51</sup> Factum Arte's photographic coverage of these three episodes is here reproduced as Fig. 14, with my annotated version of the wall-surface capture shown in positive and negative views as Figs. 15 and 16. For closer scrutiny of these walls the reader is again referred to Factum Arte's high-resolution online images.<sup>52</sup>

As with the scans of KV 62's west wall, inspection of the north wall's physical surface reveals a series of distinct, underlying features here labelled 1-6. Of these traces, no. 1 runs somewhat irregularly the full height of the wall to connect with a major fault stretching diagonally across the ceiling (see Fig. 4);<sup>53</sup> no. 2 – vertical and exceptionally clear – runs intermittently down towards the floor from a distinct dog-leg fissure close to the ceiling; while, adjacent to the east wall, no. 3 – again strikingly vertical and sharply if sporadically defined – follows a course closely similar to that of no. 2. Nos. 4-6 will be discussed presently.

While no. 1 is demonstrably natural, two features suggest that lines 2 and 3 are to be understood as artificially cut and thus archaeologically significant.

The first of these features is the dog's-leg opening located at the top of vertical no. 2 (Fig. 17, above), whose positioning, angle and course virtually replicate a type of settlement crack associated with contraction within an artificially built partition wall (Fig. 17, below).

In combination with the sharp verticality of the remainder of feature no. 2, it is possible that we are here presented with evidence for yet another undisclosed blocking within KV 62, this time beneath

the painted north wall at its eastern end – significantly distant, it may be noted, from that wall's rock-cut amuletic niche (see above). If so, then feature no. 3 presumably establishes that blocking's furthest extent – with the gap between 3 and the east wall signalling the presence of a stepped jamb similar to that encountered to the left of the Treasury doorway J-Ja (cf. Fig. 9, left).

A second indicator that these north wall traces may be meaningful is their interplay with other features of the tomb's design. Particularly revealing is the fact that the putative partition's left-hand (western) edge – vertical no. 2 – lines up precisely with the Antechamber's west wall, as if in direct continuation of it (Fig. 18). This correlates in turn with differences in cutting observed within the Burial Chamber's architecture – differences which reveal room J to have been enlarged westward along this very same line<sup>54</sup> (Fig. 19).

The pieces of the jigsaw begin to fall convincingly into place. Evidently the Antechamber (I) and Burial Chamber (J) had originally taken the form not of separate rooms but of a single, extended corridor – a corridor which gives every appearance of proceeding deeper into the *geb*, beyond the Burial Chamber's decorated north wall.

This recognition is significant, because if KV 62 had indeed begun its existence as a corridor-tomb its precise form will tell us who, in broad terms, it had originally been commissioned for. In the same way that a leftward orientation characterizes the tomb of a king at this period (cf. Fig. 12, right), a corridor-tomb with rightward axial turn seems to be indicative of queenly use.<sup>55</sup> The establishing parallel is WA D:<sup>56</sup> a right-turning corridor-tomb prepared for Hatshepsut in her role as principal consort of Thutmose II.<sup>57</sup> The

<sup>54</sup> Wong et al. 2012, S323, fig. 2; Weeks 2009, 16 (not seen).

<sup>55</sup> My earlier thought had been that KV 62 perhaps turned to the right for the same reason that those quarrying KV 56 had failed to complete the right-hand side of that tomb's single chamber – namely, to avoid collision with possible tomb or tombs lying unknown in the area between these two burials. For likely indications of two further tombs somewhere in the vicinity see Reeves 2002b, 9.

<sup>56</sup> Carter 1917, 107-118, pl. XXI. Other right-turning tombs prepared for queens include KV 20 (Hatshepsut), AN B (Ahmose-Nefertiri), DB 358 (Ahmose-Meryetamun), and perhaps DB 320 (the royal cache) and WC A and B – for the plans of which see conveniently Thomas 1966.

<sup>57</sup> One implication of this understanding would be that KV 55 was indeed begun to receive the burial of Tiye, as I have long advocated though on different grounds: Reeves 1981a, 48-55; Reeves 1990a, 43-44. On the other recognizable (and lesser?) type of Eighteenth Dynasty queenly tomb found in the Valley of the Kings – that with a single-columned burial chamber – see Reeves 2003, 69-73.

Jc-Jcc-Jccc: see *ibid.* and above, n. 11. It is probable that the WV 22 side-rooms were originally intended to be covered by the burial-chamber decoration.

<sup>50</sup> Which inevitably brings to mind the empty "transport-coffins" of KV 63 – for which see further above, n. 14.

<sup>51</sup> Robins 2007, 324-327.

<sup>52</sup> <http://www.highres.factum-arte.org/Tutankhamun/> (accessed July 16, 2015).

<sup>53</sup> Also Reeves 1990b, 71.

similarities between WA D and the core-plan now discerned for KV 62 are striking (Fig. 22), and powerful evidence that the original owner of Tutankhamun's tomb had in fact been a royal woman.

To return to the perceived continuation of this queenly corridor-tomb beyond the Burial Chamber's north wall: discrete evidence in its support may be gleaned from other features within the Factum Arte scan – specifically, those traces designated 4-6 in Figs. 15-16. Albeit somewhat fugitive, the traces are sufficient to suggest, within this partition, the outline of an internal doorway (Fig. 20). It is possible to discern not only the paired jambs of this proposed access (nos. 4, 6), but also the general location of its lintel – a presence which plaster roughly applied at point 5 with the intention to conceal in fact serves only to highlight.

As already mentioned, a blocking very similar to this had been encountered by Carter separating the outer section of the tomb from Tutankhamun's Burial Chamber (J) (Carter no. 028) (Fig. 21). The employment at this point of a partition rather than a simple rock-cut doorway is explained both by the manner in which the tomb's ground plan had developed, and by the reasoning behind that development. As we have discerned, the Antechamber (I) and Burial Chamber (J) had started out not as separate rooms at all, but as a single access route – a route which, in its first, queenly manifestation, presumably replicated in its width the narrow, preceding entrance-corridor B (cf. Fig. 30). An access route is what this section of the tomb would remain, with its subsequent enlargement to current Antechamber width necessitated by what it had been necessary to manoeuvre through it and beyond: namely, the huge, gilded wood panels of Tutankhamun's sepulchral shrines.<sup>58</sup>

The indications now of a second partition wall with internal doorway, located deeper within this same notional corridor and hidden beneath the Burial Chamber's north wall decoration, makes two important points. First, the form of this putative blocking, with the need for on-going access implied by its inner doorway, confirms that whatever lies beyond this north wall had indeed been conceived as a corridor-continuation; it did not represent the mere tidying-up of an unfinished and uneven section of quarrying. Secondly, the blocking's width suggests that this corridor-continuation had maintained these Antechamber-like proportions and for the same practical reason: the need to facilitate, this time at a previous stage in the history of KV 62, the introduction into the tomb's hidden depths of equally massive items of burial furniture. The evidence, in

short, points to the establishment beyond this point of a second, earlier interment surrounded by a similar, regal nest of enormous, gilded shrines – in other words, to the burial within KV 62 of another pharaoh.

It begins to look as if Egyptology's traditional reading of KV 62 as a small, private tomb subsequently enlarged to four chambers for Tutankhamun's exclusive use has been very much in error. Rather, the indications are that what we now know as KV 62 represents merely the outermost portion of an extended, corridor-style "tomb-within-a-tomb" – a considerably larger entity than previously understood, containing sequential burials of (1) an earlier queen who, by her employment of a nest of large sepulchral shrines had achieved full pharaonic status, and (2) a later male king, Tutankhamun himself, each interred within her (innermost) and his (outermost) dedicated burial apartments.<sup>59</sup>

Finally, what light do the Burial Chamber paintings themselves shed on the foregoing analysis? A 2012 survey of these by the Getty Conservation Institute (GCI) proves exceptionally informative.<sup>60</sup>

A key revelation of the Getty's recent report was that the north wall decoration of Tutankhamun's Burial Chamber (J) differs in a number of crucial respects from its three companion scenes to the east, west and south.

First, it transpires that the plaster + paint sequence discerned for the north is quite distinct from the relatively consistent stratigraphy shared by the Burial Chamber's east, west, and south wall surfaces<sup>61</sup> (cf.

---

<sup>59</sup> Cf. the (planned) burials of Tiye and Sitamun in suites Jc-Jcc-Jecc and Jb-Jbb respectively within the tomb of Amenhotep III (WV 22) (Hayes 1935, 29); and the Amarna royal tomb (TA 26), which seems at one stage to have been intended to receive, in its separate forks, the burials of Akhenaten and his co-regent Neferneferuaten (Reeves 2001a, 129, 179). The tomb-within-a-tomb concept was taken up again during the Nineteenth Dynasty with KV 14 – for the plan of which see Reeves and Wilkinson 1996, 157-158.

<sup>60</sup> Wong et al. 2012.

<sup>61</sup> The principal difference between the stratigraphy of the east, west and south walls is in the occurrence on the west wall of a "Coarse gray layer" ( $f_2$ ) between the universal "Coarse brown plaster" (g) foundation and the similarly occurring "Fine buff plaster" ( $d_2$ ) (see the GCI chart reproduced as Fig. 23 in this paper). This may indicate that the west wall had been plastered before those of the east and south; alternatively, if the Getty sampled at the edges of the four niches, which seems likely, then layer  $f_2$  may represent nothing more than an accidental smear from the plastered closure of one or both of the putative new blockings underlying the west and north scenes. Whatever the precise explanation, the presence on the west of the grey plaster layer  $f_2$  directly over the coarse brown levelling plaster g surely indicates that any storeroom concealed beneath – or at least its stocking and subsequent sealing – does indeed

---

<sup>58</sup> Cf. Carter (and Mace) 1923-1933, II, 39-53.

Fig. 23) – the last demonstrably a decoration applied only after the introduction into J of Tutankhamun’s large gilded shrines and the subsequent erection of the Antechamber-Burial Chamber partition (Carter 028).

A second important difference noted by the GCI is the complete absence from the north wall of those snapped paint guide-lines employed in the laying-out of the scenes of room J’s east, west and south walls; on the north, the proportions of the design had been fixed instead by means of simple incisions in the plaster.<sup>62</sup>

Third, and most telling of all, is the Getty’s discovery that the ancient palette of KV 62’s north wall differed markedly from that we see today. Unlike the east, west and south walls, whose scenes were painted onto a yellow (over white) ground, on the north wall the decoration had been executed directly on white; as the Getty team was able to establish, its present yellow ground (brighter than the yellow of the east, west, and south walls, as the north wall’s greens were also somewhat paler) represented a subsequent adaptation achieved by the simple expedient of painting around the existing figures<sup>63</sup> (cf. Fig. 24).

With evidence for (1) a divergent paint/plaster sequence, (2) a decoration laid out by a variant method, and (3) the employment of a different ground-colour, it is impossible to avoid the conclusion that the Burial Chamber’s north wall had been decorated independently of, and at an earlier date than, its Tutankhamun-era, yellow-ground fellows – this latter inference confirmed by the north’s employment of an earlier, Amarna-style, 20-square grid in contrast to the later, 18-square proportions seen in the south and (seemingly) the east and west walls also<sup>64</sup> (Fig. 25).

Prior to chamber J’s adaptation to receive Tutankhamun’s interment, therefore, the north wall scene must have already been in existence, and (unless there are earlier paintings now concealed beneath the east, west and south walls) apparently as that room’s sole decorated surface; and, with figures painted directly on a white background, this scene presumably had no association with any pre-Tutankhamun “House

of Gold,” or burial chamber. What, then, had been its intended function? With the apparent continuation of KV 62 beyond this point, a likely explanation may be proposed: that the original role of this white-ground decoration had been that of a “blind” – a decorated barrier erected with the twin aims of applying ritual protection to, and the concealment of, additional, pre-Tutankhamun chamber(s) beyond.

Such corridor concealments were a subterfuge resorted to frequently in the Valley of the Kings,<sup>65</sup> and indeed they occur too within other royal burials elsewhere.<sup>66</sup> All New Kingdom and later instances known to me present depictions of pharaoh in the presence of a variety of gods – the same general subject matter as KV 62’s north wall;<sup>67</sup> and their favoured location was the far side of the tomb’s “well”<sup>68</sup> – to which, in the compressed plan of KV 62, Carter considered room J at one stage to have corresponded.<sup>69</sup> The sole significant difference between the KV 62 north wall painting and those corridor concealments of which we have any knowledge in the Valley of the Kings is that all of the

---

date from chamber J’s later, Tutankhamun phase (see above).

<sup>62</sup> Wong et al. 2012, S327.

<sup>63</sup> Ibid.

<sup>64</sup> Robins 1984; only on the north and south walls is the position of the knee – from which the proportions are determined (the soles of the feet to the top of the knee representing one third of the figure’s height to the chin in the case of a 20-square proportional grid, and one third of the figure’s height to the hairline in the case of the 18-square grid) – clearly visible. As Robins observes (28), though fails to develop, “It is extraordinary to find the two canons used side by side on the same monument”. See also Robins 2007.

---

<sup>65</sup> The feature is first noted by Giovanni Battista Belzoni in the tomb of Seti I (KV 17) in 1817: “The little aperture we found to be an opening forced through a wall, that had entirely closed the entrance, which was as large as the corridor. The Egyptians had closely shut it up, plastered the wall over, and painted it like the rest of the sides of the pit, so that but for the aperture, it would have been impossible to suppose, that there was any farther proceeding; and any one would conclude, that the tomb ended with the pit ...” (Belzoni 1820, 233. For a later photograph, showing the “blind” completely removed, see Hornung 1999b, pl. 56. Cf. also the similar situation described in the tomb of Horemheb (KV 57): “Above this well, ... the walls on three sides were covered with paintings, but the one opposite to the entrance to this pit had been partly destroyed, showing that the robbers ... had not been deceived by the painted wall, but had broken through the concealed entrance and found their way to the funeral chambers, ruthlessly destroying their beautiful and valuable contents” (Davis 1912, 2; cf. pls. XXVI and XXX, and Fig. 26 here).

<sup>66</sup> For a similar and this time successful concealment at Tanis, of the burials of Psusennes I and Amenemope, see Montet 1951, pls. IV and XI.

<sup>67</sup> Including Thutmose IV (KV 43), Amenhotep III (WV 22), Horemheb (KV 57), and Seti I (KV 17).

<sup>68</sup> Thomas 1966, 77; Hornung 1990, 208-210; Hornung and Staehelin 2004, 61. The latter write: “The well shaft has been interpreted as being a safeguard from tomb robbers as well as a means for collecting rainwater that has seeped in; but it also has a religious meaning, in the sense of being the direct connection to the underworld and the cave of the god Sokar. In later tombs its back was walled up and, like the other walls, decorated with scenes of deities, making it look like the end of the tomb complex; its decoration made it a place where the deceased pharaoh entered the world of the gods.” See further Abitz 1979.

<sup>69</sup> Carter (and Mace) 1923-1933, III, v.

latter had been breached in distant antiquity, with the burials they sought to protect completely plundered (Fig. 26).<sup>70</sup> It seems that in KV 62 we may be faced, for the very first time, with a Valley of the Kings corridor “blind” which has survived structurally intact.

So whose burial had this north wall partition been erected to hide and protect? Most of the evidence is already to hand. From its right-turning, L-shaped plan we are able to discern that KV 62 had originally been quarried for a queen; and that this was a queen upon whom were subsequently bestowed the trappings of kingship is indicated both by the regal iconography of the north wall’s original, white-ground scene, and by the corridor the blocking beneath this painting appears to conceal – a corridor made sufficiently large to permit the passage of enormous, pharaonic-style shrine panels. The proportions employed in the layout of this north wall’s concealing scene, moreover, are those generated by a 20-square, Amarna-style grid. On these criteria there would seem to be but one viable candidate: Nefertiti as sole ruling king – i.e. as Smenkhkare.

What is more, this mooted ownership may seemingly be demonstrated. Although the original, identifying inscriptions of the north wall decoration are now completely covered by later yellow over-paint, the still-exposed figures of this original scene continue to display a good deal of attributable detail. In the case of the principal participant – those images of the pharaoh currently labelled as Tutankhamun (and of the divinities who carry this same royal face) – the first and most revealing feature to be observed is an obvious line extending downwards on either side of the mouth. This so-called “oromental groove”<sup>71</sup> is regularly encountered as a defining feature of Nefertiti’s later sculptural representations,<sup>72</sup> and it appears in combination with other features assignable to this same woman including a somewhat “scooped” brow and nose and a straight jawline with gently rounded chin. Not all of these features may now be

observed in all of the relevant north wall figures,<sup>73</sup> but for this there is a reason. Following the repainting in yellow of the north wall’s white background, clearly there had been a need for the profiles to be neatened up, and this seems in places to have been carried out somewhat carelessly. Where the need for such re-outlining had been minimal, however – as, for example, in the case of the beard-wearing gods – the jawline and chin are preserved as originally drafted, and their original forms readily discerned (Fig. 27).

But it is in the facial structure of the second, ministering pharaoh in the Opening of the Mouth ceremony that we find final confirmation of the Nefertiti attribution. The *sem*-priest’s distinctive double under-chin is a feature not present in any image currently recognizable as Ay, for whom this KV 62 figure is now labelled;<sup>74</sup> unless added in error at the time of the north wall background’s repainting and the figure’s reassignment to Ay, it too must be a carry-over from the scene’s original, white-ground employment as a corridor “blind” erected at the time of Nefertiti’s funeral. The chin is very clearly that of an Amarna child,<sup>75</sup> and in the present context that child is surely Tutankhamun (Fig. 28) – to whom, as Nefertiti’s successor, fell the responsibility of ensuring that his predecessor was accorded a full, Osirian burial. As the face of KV 62’s pharaonic *sem*-priest now suggests, it was a responsibility the young successor carried out to the letter, establishing for eternity not merely his piety but the very legitimacy of his accession (Fig. 29).

## CONCLUSIONS

The evidence presented in this paper points cumulatively and compellingly towards the existence of a significantly larger ground plan for KV 62 than has previously been acknowledged. At least two new elements are here proposed: (1) a further storage room on the west of the Burial Chamber, seemingly contemporary with the Annexe and the burial of

<sup>70</sup> As Hornung 1990, 208, dramatically observes, “All offerings and royal treasures lay beyond this wall.”

<sup>71</sup> Taylor 2001, 265, fig. 8.11.

<sup>72</sup> Even on her famous painted limestone bust in Berlin, though here it was rendered deliberately less obvious by the application of a secondary layer of plaster. Cf. Hupperts et al. 2009. The fact that the figure of the king wearing the *khat*-headdress on the Tutankhamun-era south wall of the KV 62 Burial Chamber displays the same oromental groove – which is not a standard facial characteristic of this king – may be a consequence of the ancient artists’ desire to impose a degree of consistency on the finished whole. This inclination is seen elsewhere in these scenes, both earlier and later, in the universal employment of the so-called “Amarna navel” – and, of course, in the desire to match the colouring of the walls.

<sup>73</sup> Interestingly, the faces of the goddesses on the north and south walls are quite different, both from those of the pharaoh and Osiris images and from each other – suggesting that the face of Nut on the earlier north may, with its low nose, horizontal chin-line, and deeper chin (encountered also on Tutankhamun’s shrines III and IV – e.g. Piankoff 1951, pls. X, XII, XX), be intended as an image of Meritaten, (ritualistic) great royal wife of Neferneferuaten/Smenkhkare. The features of the goddess Isis in the later, south wall decoration would accordingly have been influenced by those of Tutankhamun’s own consort, Ankhesenamun.

<sup>74</sup> See Reeves in press b.

<sup>75</sup> Davies 1921, pl. I.

Tutankhamun; and (2), to the north, an earlier corridor of Antechamber width which continues deeper into the gebel (see Frontispiece).

The likely developments in the tomb's design and use may now be charted (Fig. 30). The initial form of KV 62 is established as a narrow, L-shaped corridor-tomb, with the distinctive turn to the right (rather than to the kingly left) identifying its primary owner as a queen. Two features combine to mark out this woman as a queen who ultimately achieved full regal status. These are: (1) the pharaonic character of the Burial Chamber's pre-Tutankhamun north wall scene; and (2) the corridor-continuation this decoration appears to conceal, cut at the same enlarged, Antechamber width and presumably to permit the ingress of massive, pharaonic-style shrine panels. Only one female royal of the late Eighteenth Dynasty is known to have received such honours, and that is Nefertiti. It is not by chance, therefore, that Nefertiti's image may be discerned in this north wall's decoration – which must have been erected as a “blind” following her interment here as pharaoh, to conceal the presence of a corridor-continuation and burial beyond.

Nefertiti had begun her career as great royal wife to Akhenaten, and was promoted as co-regent in or after his sixteenth regnal year, adopting an elaborated version of her queenly name contained within a pair of cartouches: Ankhkheperure (+ epithet) Neferneferuaten (+ epithet). As co-regent, Nefertiti's iconography was enhanced to incorporate emblems of a distinctly royal character, including the *nemes*-headdress – as seen in her burial equipment later appropriated by Tutankhamun.

Following Akhenaten's death, the junior co-regent will have assumed formal control of Egypt as a matter of course. As full pharaoh her prenomen was modified by removing those earlier epithets declaring her previous dependence on Akhenaten; her nomen was entirely new – “Smenkhkare-djeserkheperu”. After a brief, independent reign of perhaps no more than a few months – during which she will have issued her fateful appeal to Suppiluliuma I, king of the Hittites, to send a son to rule Egypt by her side – Nefertiti disappears from view, presumably having died or been killed. Responsibility for the subsequent funeral fell to her immediate successor, Tutankhamun – the Amarna prince whose distinctive double underchin is recognizable still in the face of the king shown within KV 62 officiating at Nefertiti's Opening of the Mouth ceremony.

The proposal here put forward – that KV 62 had been both initiated and employed for the burial of Nefertiti – ties in with evidence already noted for Tutankhamun's re-use of the larger part of this same woman's co-regent-status burial furniture. As I have

argued, the fact that Nefertiti failed to employ this semi-pharaonic equipment can point to only one thing – that in the end, as sole ruler, she had been entitled to the more elaborate funerary paraphernalia of a fully fledged king. Although it cannot yet be proven, it is my guess that Nefertiti will have inherited, adapted, and employed the full, formal burial equipment originally produced for Akhenaten. Certainly it is improbable that there was time for Smenkhkare herself to have prepared from scratch an entirely new funerary assemblage.

At the time of Nefertiti's burial within KV 62 there had surely been no intention that Tutankhamun would in due course occupy this same tomb. That thought would not occur until the king's early and unexpected death a decade later. With no tomb yet dug for pharaoh's sole use, KV 62 was reopened and accessed up to and including chamber J. This restricted space was then physically enlarged to receive a second burial, with room J – the notional “well” of Nefertiti's tomb – reconfigured to become Tutankhamun's Burial Chamber, or “House of Gold.”

This transformation was achieved by applying yellow paint around the figures of the room's white-ground north wall, and by adding to this new background fresh columns of text reassigning Nefertiti's images to their new owner, Tutankhamun, and that of the original officiating *sem*-priest, Tutankhamun, to Ay. At the same time, this once-independent north wall decoration was supplemented by three entirely new scenes executed directly on yellow, with the painting on the west effectively concealing from view the entrance to one of Tutankhamun's freshly quarried and stocked orbital chambers. With its entrance cut to match that of the Annexe, this still-hidden room had probably been employed to store further Tutankhamun burial equipment; not impossibly, however, it may have been used to cache those further members of the Amarna royal family whose mummies were now seeking a new, Theban home. Finally, amuletic recesses were cut into each of the Burial Chamber's four walls, irregularly but deliberately positioned so as to penetrate only the living rock and avoid compromising the chamber's known partitions and closures.

Possibly, by the time Tutankhamun's burial came to be robbed shortly after the funeral, Nefertiti's presence behind the north wall “blind” was already forgotten; perhaps, and more likely, the robbers simply had insufficient time to investigate, choosing to focus instead on those abundant riches readily to hand. Three and a half thousand years later Howard Carter had the time, but he lacked the technology to see beneath the tomb's painted walls. Accepting the oddly positioned rock-cut niches as evidence that the Burial

Chamber's walls were completely solid, he brought his search to a close – wholly unaware that a more significant find by far may have been lying but inches from his grasp.

Nicholas Reeves  
July 23, 2015



## REFERENCES

- Abitz, Friedrich  
1979 *Die religiöse Bedeutung der sogenannten Grabräuberschächte in den ägyptischen Königsgräbern der 18. und 19. Dynastie* (Wiesbaden: Otto Harrassowitz)
- Allen, James P.  
2009 "The Amarna Succession," in Brand, Peter J. and Louise Cooper, eds., *Causing his Name to Live: Studies in Egyptian Epigraphy and History in Memory of William J. Murnane*, 9-20
- Arnold, Dorothea, ed.  
2010 *Tutankhamun's Funeral* (New York: Metropolitan Museum of Art)
- Beinlich, Horst and Mohamed Saleh  
1989 *Corpus der hieroglyphischen Inschriften aus dem Grab des Tutanchamun* (Oxford: Griffith Institute)
- Bell, Martha R.  
1990 "Notes on the Exterior Construction Signs from Tutankhamun's Shrines," *Journal of Egyptian Archaeology* 76, 107-124
- Belzoni, Giovanni Battista  
1820 *Narrative of the Operations and Recent Discoveries in Egypt and Nubia* (London: John Murray)
- Carter, Howard  
1916 "Report on the Tomb of Zeser-Ka-Ra Amenhetep I, Discovered by the Earl of Carnarvon in 1914," *Journal of Egyptian Archaeology* 3, 147-154  
1917 "A Tomb Prepared for Queen Hatshepsut and Other Recent Discoveries at Thebes," *Journal of Egyptian Archaeology* 4, 107-118
- Carter, Howard and Alan H. Gardiner  
1917 "The Tomb of Ramesses IV and the Turin Plan of a Royal Tomb," *Journal of Egyptian Archaeology* 4, 130-158
- Carter, Howard (and Arthur C. Mace)  
1923-1933 *The Tomb of Tut. ankh. Amen, I-III* (London: Cassell and Company)
- Černý, Jaroslav  
1973 *The Valley of the Kings. Fragments d'un manuscrit inachevé* (Cairo: Institut français d'Archéologie orientale)
- Davies, Norman de Garis  
1905 *The Rock Tombs of El Amarna, Part II. The Tombs of Panehesy and Meryra II* (London: Egypt Exploration Fund)  
1921 "Mural Paintings in the City of Akhetaten," *Journal of Egyptian Archaeology* 7, 1-7
- Davis, Theodore M.  
1912 *The Tombs of Harmhabi and Touatânkhamanou* (London: Constable and Company Ltd)
- Dodson, Aidan  
2009 *Amarna Sunset. Nefertiti, Tutankhamun, Ay, Horemheb, and the Egyptian Counter-Reformation* (Cairo: American University in Cairo Press)
- Eaton-Krauss, Marianne  
1993 *The sarcophagus in the tomb of Tutankhamun* (Oxford: Griffith Institute)  
1994 "Tutankhamun's sarcophagus: an addition and two corrections," *Journal of Egyptian Archaeology* 80, 217-218  
1998 "The sarcophagus in the tomb of Tutankhamun: a clarification," *Journal of Egyptian Archaeology* 84, 210-212

- 2009-2010  
 “The Burial of Tutankhamen, Part One,”  
*Kmt* 20/4 (winter), 34-47
- Engelbach, Reginald  
 1940 “Material for a Revision of the History of the Heresy Period of the XVIIIth Dynasty,”  
*Annales du Service des Antiquités de l'Égypte* 40, 133-165
- Ertman, Earl M.  
 2009 “A Unique ‘Bed’ with Lion-headed Terminals: A KV 63 Report,” *Kmt* 20/2 (summer), 44-47
- Factum Arte  
 2012 *The Authorized Facsimile of the Burial Chamber of Tutankhamun, with Sarcophagus, Sarcophagus Lid and the Missing Fragment from the South Wall* (Madrid: Factum Arte)
- von Falck, Martin  
 2012 “Zwischen Echnaton und Tutanchamun. Eine neue nachgezeichnete Skizze,” *Sokar* 25/2, 86-97
- [Forbes, Dennis]  
 2013 “Exact Facsimile of the Burial Chamber of KV 62 Gifted to Egypt,” *Kmt* 24/1 (spring), 50-63
- Gabolde, Marc  
 1998 *D’Akhenaten à Toutânkhamon* (Lyon: Institut d’Archéologie et d’Histoire de l’Antiquité)  
 2009 “Under a deep blue starry sky,” in Brand, Peter J. and Louise Cooper, eds., *Causing his Name to Live: Studies in Egyptian Epigraphy and History in Memory of William J. Murnane*, 109-120
- Gardiner, Alan Henderson  
 1928 “The Graffito from the Tomb of Pere,”  
*Journal of Egyptian Archaeology* 14, 10-11, pls. V-VI
- Hammond, Norman  
 2014 [Report on Reeves 2014], *The Times* (London), May 17
- Harris, John R.  
 1992 “Akhenaten and Nefernefruten in the tomb of Tutankhamūn,” in Carl Nicholas Reeves, ed., *After Tutankhamūn. Research and Excavation in the Royal Necropolis at Thebes* (London: KPI), 55-72
- 2008 “Apropos Nefertiti (2): Smenkhkara Resartus,” *Papyrus* 28/2, 1-7
- Hayes, William C.  
 1935 *Royal Sarcophagi of the XVIIIth Dynasty* (Princeton: Princeton University Press)
- Helck, Wolfgang  
 1984 *Urkunden des ägyptischen Altertums, IV. Urkunden der 18. Dymastie* (Berlin: Akademie-Verlag)
- Hornung, Erik  
 1963 *Das Amduat. Die Schrift des verborgenen Raumes* (Wiesbaden: Otto Harrassowitz)  
 1990 *The Valley of the Kings, Horizon of Eternity* (New York: Timken Publishers)  
 1999a *The Ancient Egyptian Books of the Afterlife* (Ithaca and London: Cornell University Press)  
 1999b *Das Grab Sethos’ I* (second edition, Düsseldorf and Zürich: Artemis and Winkler Verlag)  
 2006 “New Kingdom,” in *Ancient Egyptian Chronology*, Hornung, Rolf Krauss, and David A. Warburton (eds.) (Leiden: Brill, 2006), 197-218
- Hornung, Erik and Elisabeth Staehelin  
 2004 “The Valley of the Kings in the 18<sup>th</sup> Dynasty,” in André Wiese and Andreas Brodbeck, eds., *Tutankhamun, the Golden Beyond. Tomb Treasures from the Valley of the Kings* (Basel: Antikenmuseum Basel und Sammlung Ludwig), 57-82
- Hupperts, Alexander, Dietrich Wildung, Barry J. Kemp, Tanja Nentwig, Patrick Asbach, Franz Maximilian Rasche, and Bernd Hamm  
 2009 “Nondestructive Insights into Composition of the Sculpture of Egyptian Queen Nefertiti with CT,” *Radiology* 251/1 (April), 233-240
- Johnson, George B.  
 1993-1994  
 “KV 62: Its Architecture and Decoration,”  
*Kmt* 4/4 (winter), 38-47
- Kondo, Jiro  
 1995 “The Re-clearance of Tombs WV 22 and WV A in the Western Valley of the Kings,” in Richard H. Wilkinson, ed., *Valley of the Sun Kings. New Explorations in the Tombs of the Pharaohs* (Tucson: University of Arizona), 25-33

- Loeben, Christian E.  
 1986 "Eine Bestattung der großen königlichen Gemahlin Nofretete in Amarna," *Mitteilungen des Deutschen Archäologischen Instituts, Abteilung Kairo* 42, 99-107  
 1999 "Une inhumation de la grande épouse royal Néfertiti à Amarna?" *Égypte Afrique et Orient* 13, 25-30
- Miller, Jared L.  
 2007 "Amarna Age Chronology and the Identity of Nibhururiya in the Light of a Newly Reconstructed Hittite Text," *Altorientalische Forschungen* 34/2, 252-293
- Montet, Pierre  
 1951 *Les constructions et le tombeau de Psousennès à Tanis* (Paris: CNRS)
- Murray, Helen and Mary Nuttall, eds.  
 1963 *A Handlist to Howard Carter's Catalogue of Objects in the Tomb of Tutankhamun* (Oxford: Griffith Institute)
- Piankoff, Alexandre  
 1951 *Les chapelles de Tutankhamon, I-II* (Cairo: Institut français d'archéologie orientale)
- Reeves, (Carl) Nicholas  
 1978 "Nefertiti as *hmt nsw ʿ3t*," *Göttinger Miszellen*  
 1981a "A Re-appraisal of Tomb 55 in the Valley of the Kings," *Journal of Egyptian Archaeology* 67, 48-55  
 1981b "A State Chariot from the Tomb of Ay?" *Göttinger Miszellen* 46, 11-19  
 1982a "The Discovery and Clearance of KV 58," *Göttinger Miszellen* 53, 33-45  
 1982b "Akhenaten After All?" *Göttinger Miszellen* 54, 61-71  
 1990a *Valley of the Kings. The Decline of a Royal Necropolis* (London: KPI)  
 1990b *The Complete Tutankhamun* (London and New York: Thames and Hudson)  
 1990c "The Archaeological Analysis of KV55 1907-1990," in Theodore M. Davis, *The Tomb of Queen Tiye* (2<sup>nd</sup> ed., San Francisco: Kmt Communications), iv-xiv  
 2001a *Akhenaten. Egypt's False Prophet* (London and New York: Thames and Hudson)
- 2001b "Re-excavating the 'Gold Tomb,'" lecture delivered at the UCL Bloomsbury Theatre, London, at the Day School *Valley of the Kings: The Amarna Royal Tombs Project 1998-2001*, September 29. Text online at <http://www.nicholasreeves.com/item.aspx?category=Archaeology&id=257> (accessed July 16, 2015)  
 2002a "ARTP: In Search of Akhenaten's Missing Women," *Newsletter of the Valley of the Kings Foundation* 1 (summer), 5  
 2002b "Huts and Graffiti," *Newsletter of the Valley of the Kings Foundation* 1 (summer), 9  
 2003 "On Some Queens' Tombs of the Eighteenth Dynasty," in Nigel Strudwick and John H. Taylor, eds., *The Theban Necropolis, Past, Present and Future* (London: British Museum Press), 69-73  
 2011 "Recent Research in Egyptian Art. Behind the Mask of Tutankhamun," lecture delivered at the Metropolitan Museum of Art, April 3. Video online at <https://www.youtube.com/watch?v=bxN1hm1TmJ0> (accessed July 16, 2015)  
 2014 "The Gold Throne from Tutankhamun's Tomb," *65<sup>th</sup> Annual Meeting of the American Research Center in Egypt, Abstracts* (San Antonio), 71
- in press a  
 "Tutankhamun's Mask Reconsidered," in Adela Oppenheim and Ogden Goelet, eds., *The Art and Culture of Ancient Egypt. Studies in Honor of Dorothea Arnold* (*Bulletin of the Egyptological Seminar* [New York], 19)
- in press b  
 "The Coffin of Ramesses II," in *Proceedings of the First Vatican Coffin Conference, 19-22 June 2013* (Rome: Vatican Museum)
- Reeves, (Carl) Nicholas and Richard H. Wilkinson  
 1996 *The Complete Valley of the Kings* (London and New York: Thames and Hudson)
- Revez, Jean  
 2010 "Looking at History through the Prism of Mythology: Can the Osirian Myth Shed any Light on Ancient Egyptian Royal Succession Patterns?" in *Journal of Egyptian History* 3, 47-71
- Robins, Gay  
 1983a "Anomalous Proportions in the Tomb of Haremhab (KV 57)," *Göttinger Miszellen* 65, 91-96

- 1983b “The Canon of Proportions in the Tomb of Ramesses I (KV 16),” *Göttinger Miszellen* 68, 85-90
- 1984 “The Proportions of Figures in the Decoration of the Tombs of Tutankhamun (KV 62) and Ay (KV 23),” *Göttinger Miszellen* 72, 27-32
- 2007 “The Decorative Program in the Tomb of Tutankhamun,” in Zahi H. Hawass and Janet E. Richards, eds., *The Archaeology and Art of Ancient Egypt. Essays in Honor of David B. O’Connor*, II (Cairo: Conseil Suprême des Antiquités de l’Égypte), 321-342
- Steindorff, Georg  
1938 “Die Grabkammer des Tutanchamun,” *Annales du Services des Antiquités de l’Égypte* 38, 641-667
- Taylor, Karen T.  
2001 *Forensic Art and Illustration* (Boca Raton: CRC Press)
- Thomas, Elizabeth  
1966 *The Royal Necropoleis of Thebes* (Princeton: Elizabeth Thomas)
- Van der Perre, Athena  
2014 “The Year 16 Graffito of Akhenaten in Dayr Abū Hinnis. A Contribution to the Study of the Later Years of Nefertiti,” *Journal of Egyptian History* 7, 67-108
- Weeks, Kent R.  
2003 *Atlas of the Valley of the Kings. Study Edition* (Cairo: American University in Cairo Press)  
2009 *The Tomb of Tutankhamen: A Survey of its Art, Architecture, and Changing Condition* (Los Angeles: Getty Conservation Institute). Unpublished report; not seen
- Winlock, Herbert E.  
1941 *Materials Used at the Embalming of King Tutankh-Amūn* (New York: Metropolitan Museum of Art)
- Wong, Lori, Stephen Rickerby, Alan Phenix, Amarilli Rava, and Rasha Kamel  
2012 “Examination of the Wall Paintings in Tutankhamen’s Tomb. Inconsistencies in Original Technology,” in The International Institute for Conservation of Historic and Artistic Works, *The Decorative: Conservation and the Applied Arts. 2012 IIC Congress, Vienna* (London: International Institute for Conservation of Historic and Artistic Works), S322-S330
- Wong, Lori, ed.  
2013 *The Conservation and Management of the Tomb of Tutankhamen (KV 62). A Project Bibliography* (Los Angeles: Getty Conservation Institute)
- Yoshimura, Sakuji and Jiro Kondo, eds.  
2004 *Conservation of the Wall Paintings in the Royal Tomb of Amenophis III. First and Second Phase Report* (Paris and Tokyo: UNESCO and Institute of Egyptology, Waseda University)
- el Zeini and Dees 2007  
*Omm Sety’s Egypt* (Pittsburgh: St Lynn’s Press)



Fig. 1. Conspectus of Burial Chamber (J) walls, KV 62, from left to right: south (incomplete), west, north, east. Above: painted decoration. Below: surface relief  
(<http://www.highres.factum-arte.org/Tutankhamun/>, copyright © FactumArte/Ministry of State for Antiquities and Heritage, Egypt)

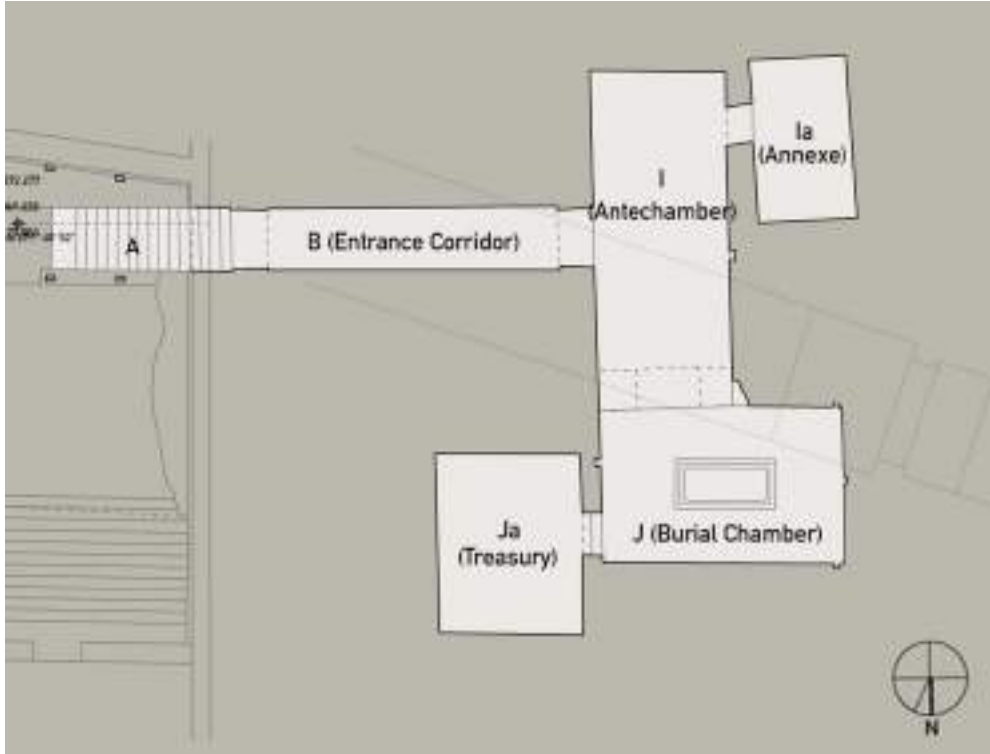

Fig. 2. Plan of the tomb of Tutankhamun (KV 62) as at present known (Weeks 2003, sheet 69/70 / <http://www.thebanmappingproject.com/>, with emendations, copyright © Theban Mapping Project)

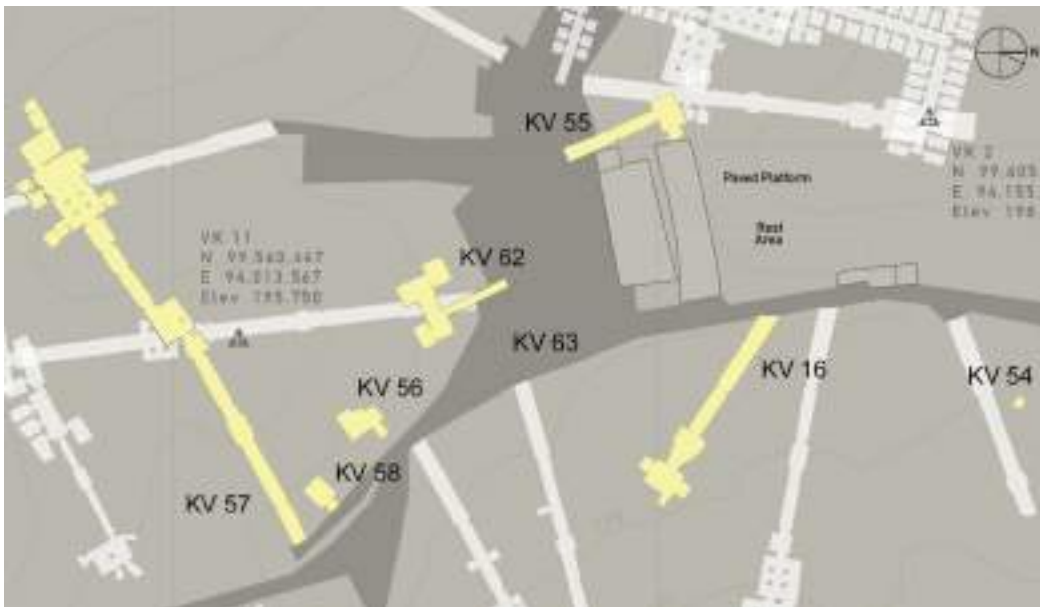

Fig. 3. KV 62 and other tombs and deposits with Amarna associations in the central Valley of the Kings (location of KV 63 approximate only) (Weeks 2003, sheet 3/70 / <http://www.thebanmappingproject.com/>, with additions, copyright © Theban Mapping Project)





Fig. 5. Burial Chamber (J), KV 62: west wall, painted decoration  
(<http://www.hghres.factum-arte.org/Tutankhamun/>, copyright © Factum Arte/Ministry of State for Antiquities and Heritage, Egypt)





Fig. 6. Burial Chamber (J), KV 62: west wall, surface relief (positive), showing numbered features  
(<http://www.highres.factum-arte.org/Tutankhamun/>, with additions, copyright © Factum Arte/Ministry of State for Antiquities and Heritage, Egypt)

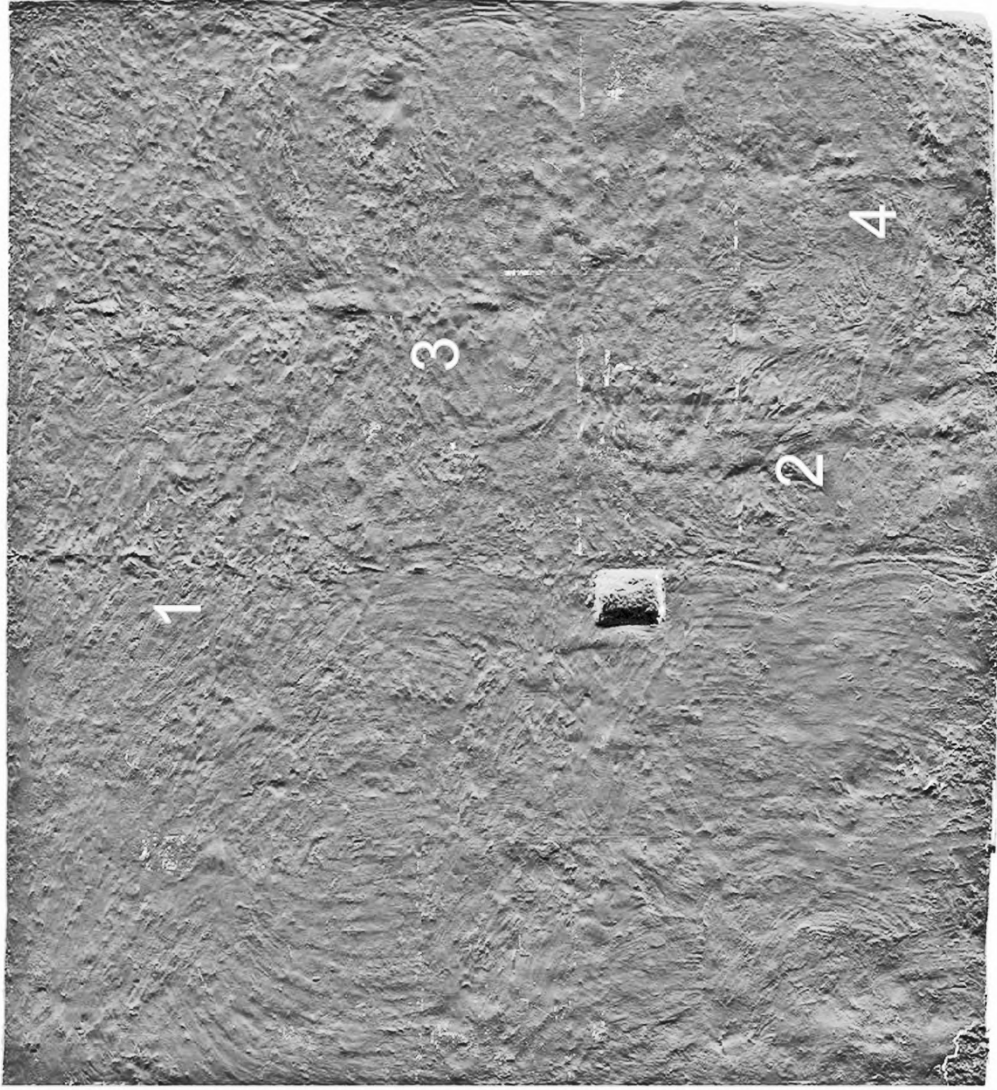

Fig. 7. Burial Chamber (J), KV 62: west wall, surface relief (negative), showing numbered features  
(<http://www.highres.factum-arte.org/Tutankhamun/>, with additions, copyright © Factum Arte/Ministry of State for Antiquities and Heritage, Egypt)

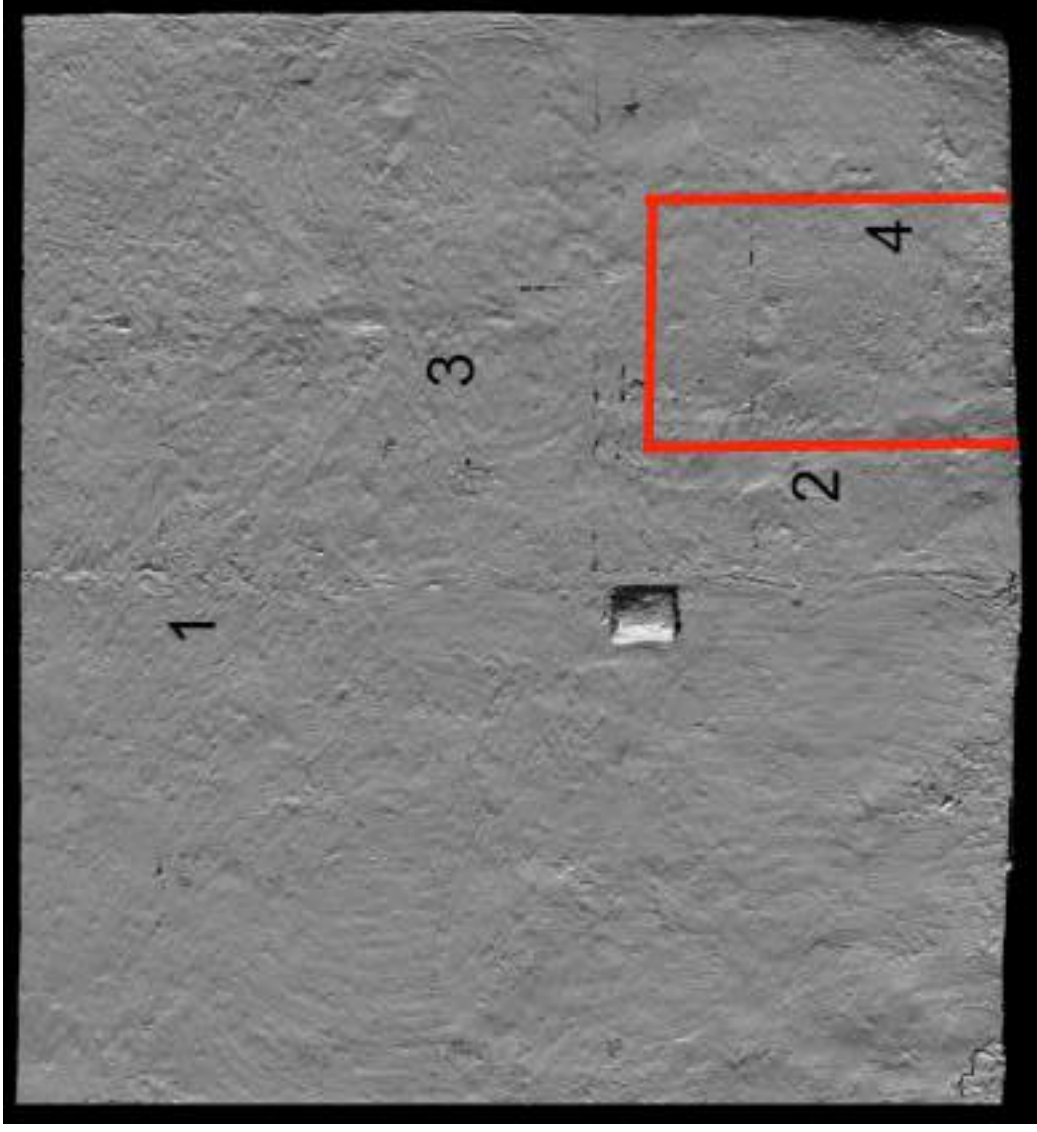

Fig. 8. Burial Chamber (I), KV 62: west wall, surface relief (positive), showing numbered features and traces of sealed doorway in red (<http://www.highres.factum-arte.org/Tutankhamun/>, with additions, copyright © Factum Arte/Ministry of State for Antiquities and Heritage, Egypt)

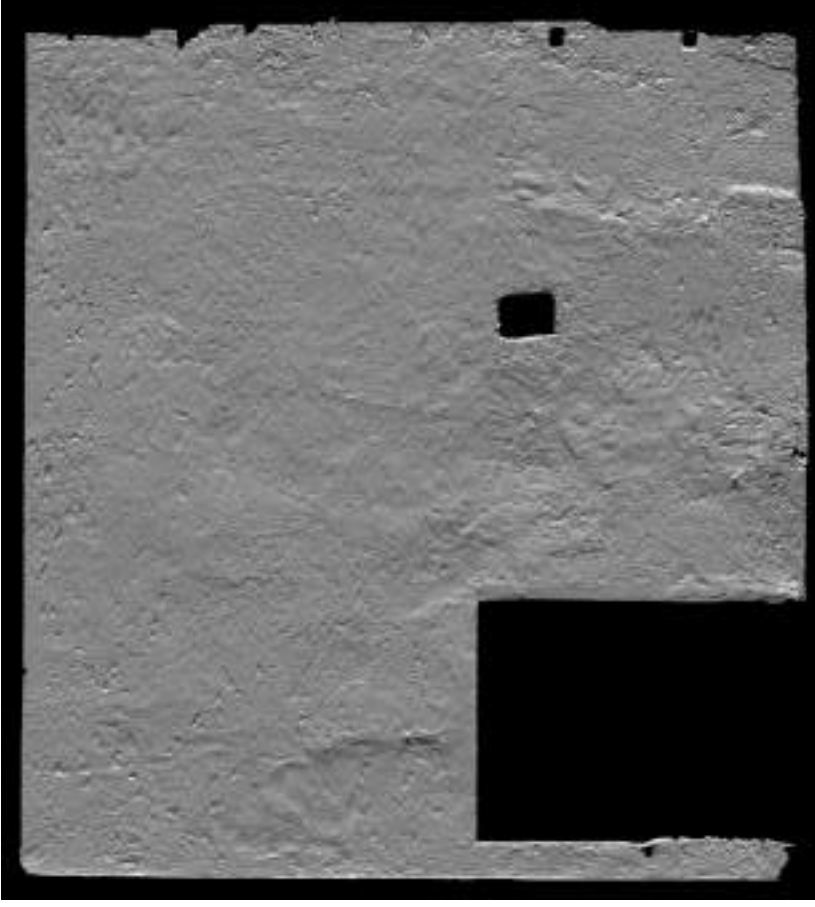

Fig. 9. Vertical faulting above door lintels in (left) KV 62 (Tutankhamun – entrance to the Treasury, Ja) and (right) WV 22 (Amenhotep III – entrance to side room Jbb) (Left: <http://www.highres.factum-arte.org/Tutankhamun/>, copyright © Factum Arte/Ministry of State for Antiquities and Heritage, Egypt. Right: after Yoshimura and Kondo 2004, 92, fig. 11, copyright © Institute of Egyptology, Waseda University/UNESCO)



Fig. 10. Antechamber (I), KV 62: west wall, showing doorway into the Annexe (Ia)  
 (Carter MSS, Burton photograph p0034a, copyright © Griffith Institute, Oxford)

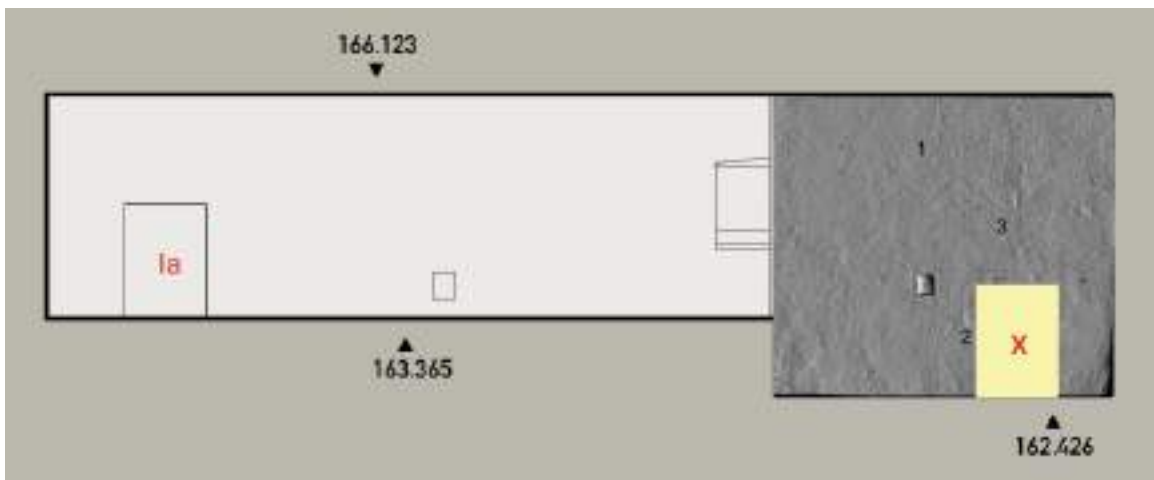
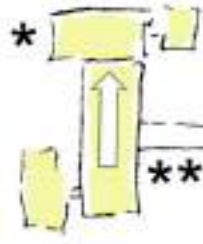
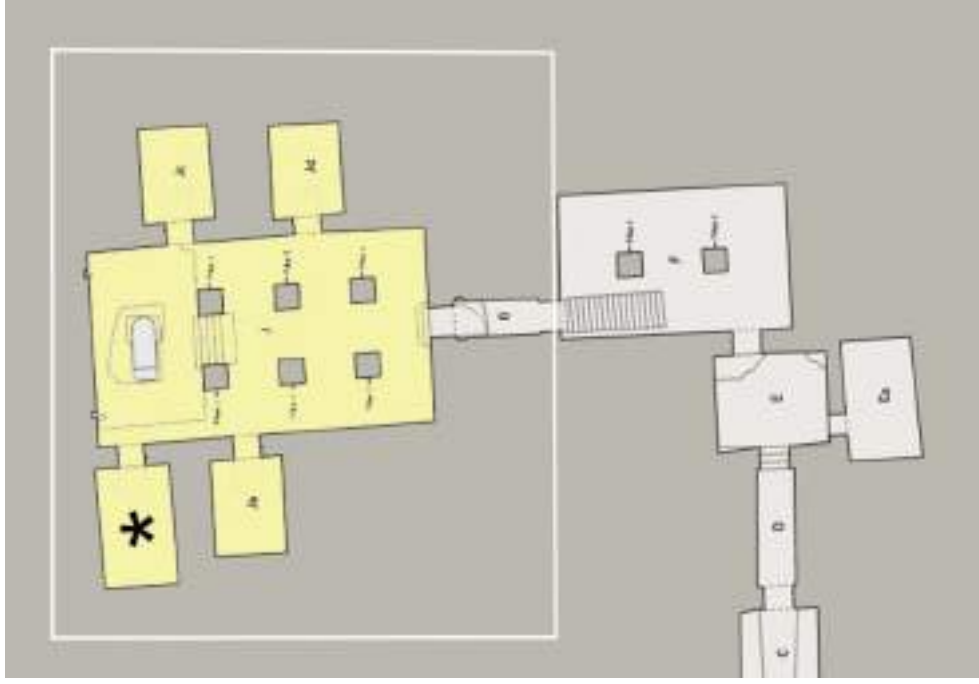
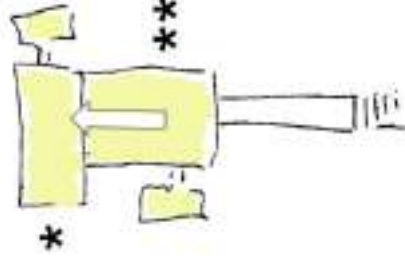

Fig. 11. Antechamber (I) and Burial Chamber (J), KV 62: section showing west wall and relative sizes of the doorway into the Annexe (Ia) and putative doorway into store room(?) (Jx)  
 (Original section Weeks 2003, sheet 69/70 / <http://www.thebanmappingproject.com/>, copyright © Theban Mapping Project, with superimposed surface scan, right, <http://www.highres.factum-arte.org/Tutankhamun/>, with additions, copyright © Factum Arte/Ministry of State for Antiquities and Heritage, Egypt)



1. Tomb plan as is



2. Tomb plan as reconciled by Carter

Fig. 12. (Left) Carter's sketch-analysis of the KV 62 ground plan: (1) as is; (2) with the chambers swung around en bloc 90 degrees counter-clockwise to correspond to the burial apartments of a typical Eighteenth Dynasty royal tomb (seen right: Amenhotep II, KV 35)  
 (Left: Reeves 1990b, 70, based on an original sketch by Carter, Carter MSS, with additions, copyright © Griffith Institute, Oxford). Right: Weeks 2003, sheet 50/70 / <http://www.thebanmappingproject.com/>, with additions, copyright © Theban Mapping Project

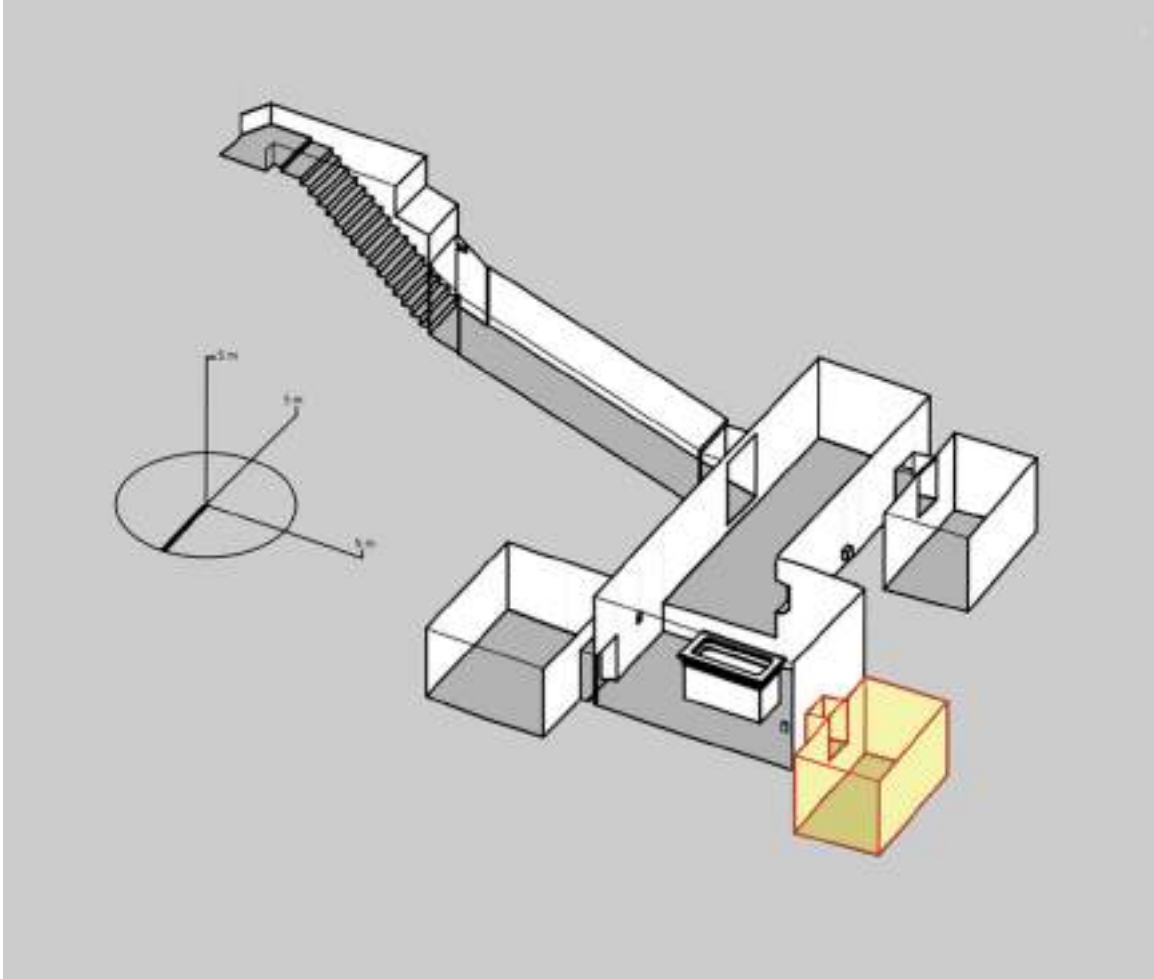

Fig. 13. KV 62, showing (in yellow) position of proposed new store room (Jx) behind the decorated west wall of the Burial Chamber (J).

(Weeks 2003, sheet 69/70 / <http://www.thebanmappingproject.com/>, with additions, copyright © Theban Mapping Project)



Fig. 14. Burial Chamber (I), KV 62: north wall, painted decoration  
(<http://www.highres.factum-arte.org/Tutankhamun/>, copyright © Factum Arte/Ministry of State for Antiquities and Heritage, Egypt)



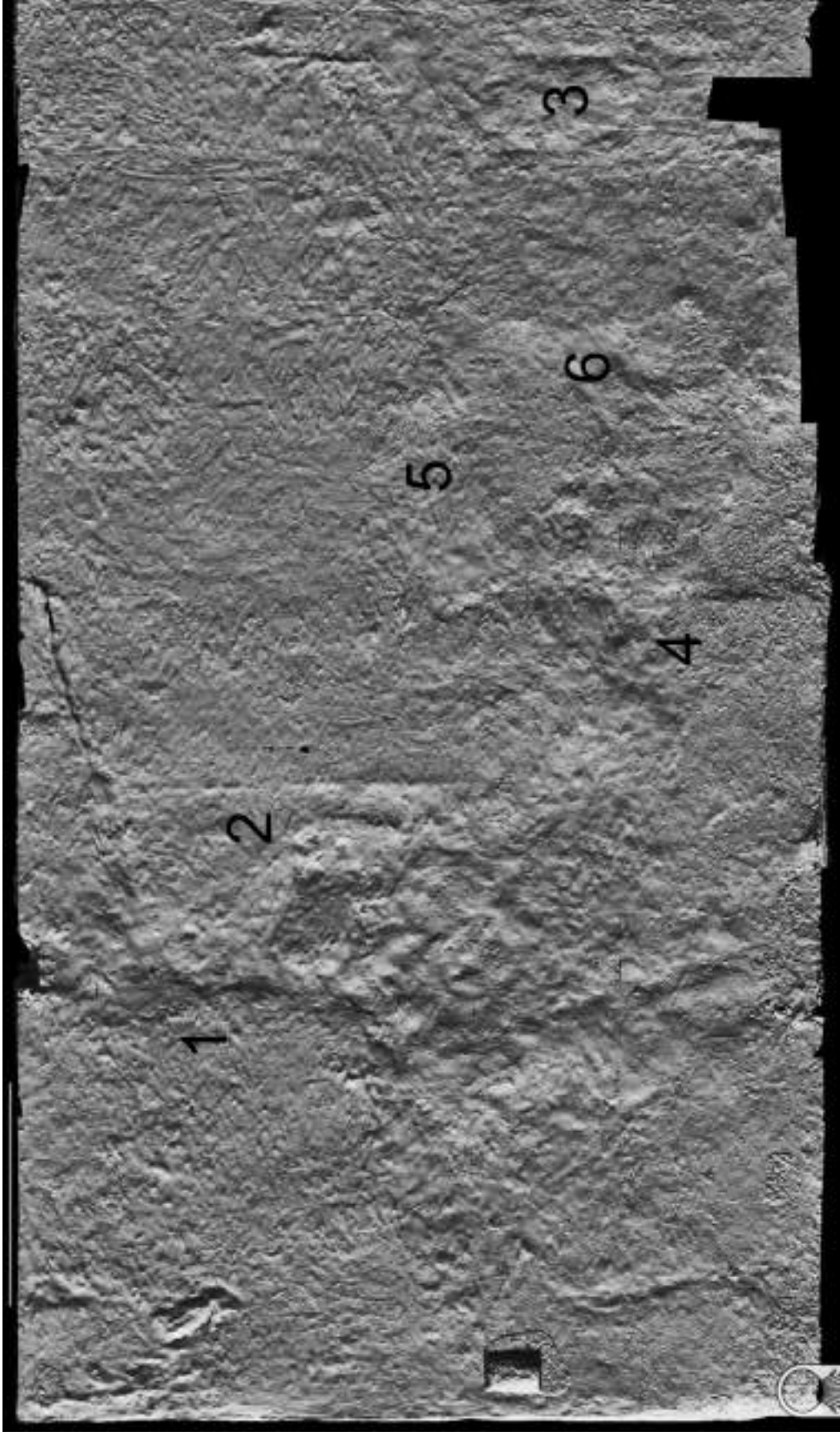

Fig. 15. Burial Chamber (I), KV 62: north wall, surface relief (positive), showing numbered features  
(<http://www.highres.factum-arte.org/Tutankhamun/>, with additions, copyright © Factum Arte/Ministry of State for Antiquities and Heritage, Egypt)

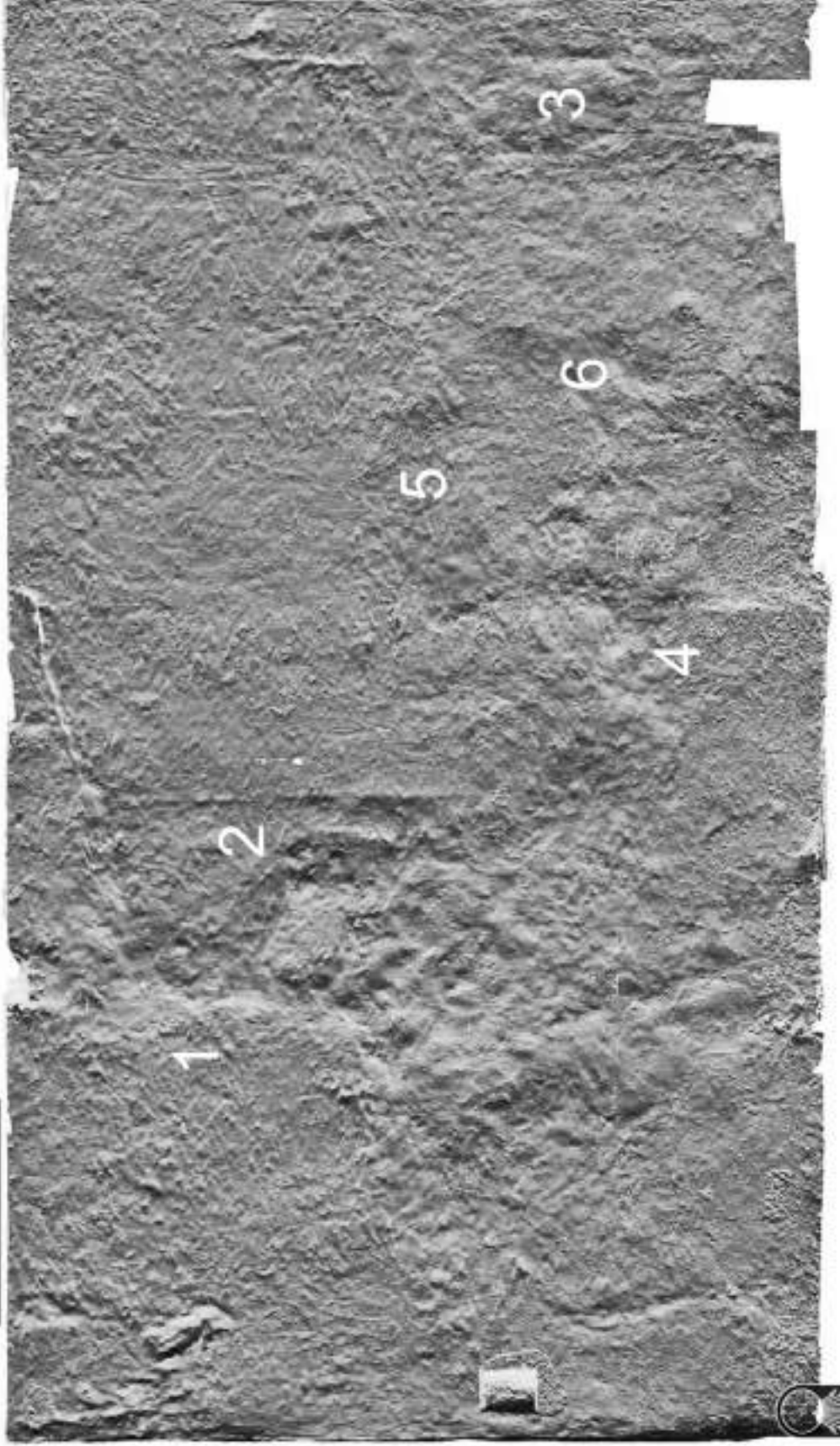

Fig. 16. Burial Chamber (I), KV 62: north wall, surface relief (positive), showing numbered features  
(<http://www.highres.factum-arte.org/Tutankhamun/>, with additions, copyright © Factum Arte/Ministry of State for Antiquities and Heritage, Egypt)

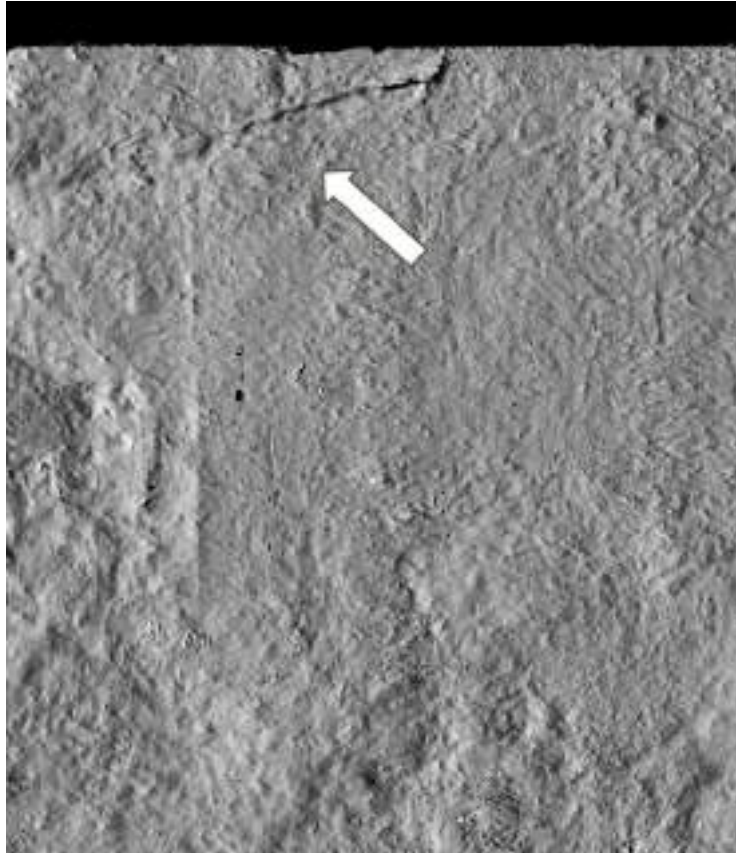

Fig. 17. Above: Burial Chamber (J), KV 62: north wall, surface relief (positive), showing diagonal separation in plastered surface. Below: Identical type of fissure as seen in a modern partition wall (Above: <http://www.highres.factum-arte.org/Tutankhamun/>, detail, with additions, copyright © Factum Arte/Ministry of State for Antiquities and Heritage, Egypt, detail. Below: after <http://inspectapedia.com/vision/SinkingHouse109DJFs.jpg>, manipulated, with additions, copyright © InspectAPedia.com 2010)

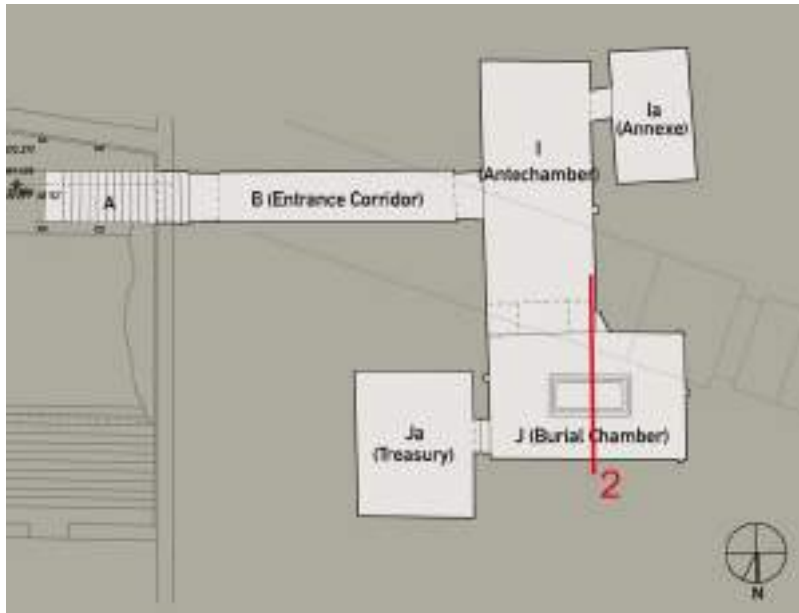

Fig. 18. Plan of KV 62, showing relief feature 2 on the surface of the Burial Chamber's north wall lining up precisely with the west wall of the Antechamber (Weeks 2003, sheet 69/70 / <http://www.thebanmappingproject.com/>, with emendations and additions, copyright © Theban Mapping Project)

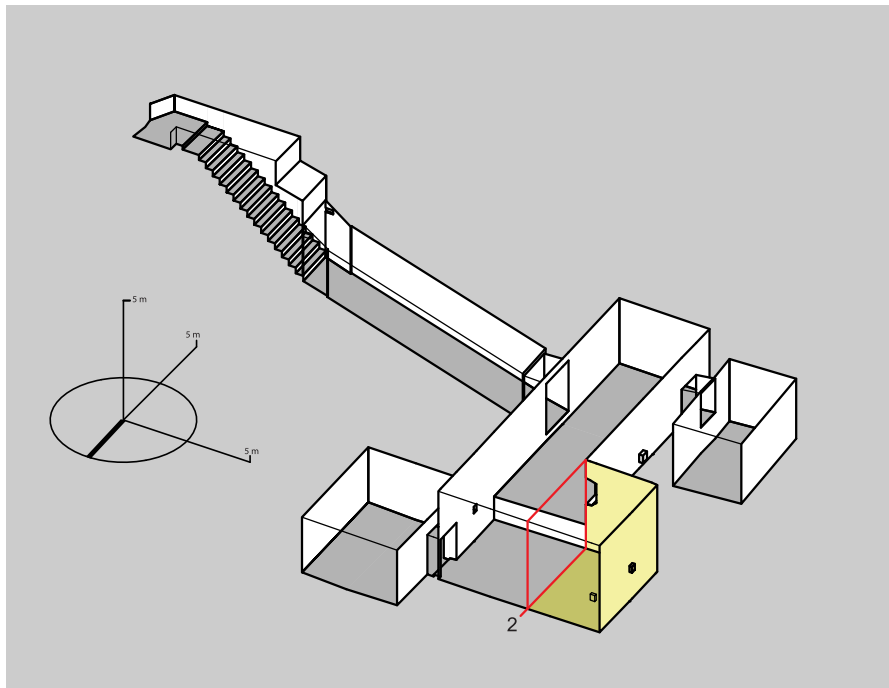

Fig. 19. KV 62, highlighting (in red) the extension to the west of the Burial Chamber (J) along line 2 (Weeks 2003, sheet 69/70 / [http://www.thebanmappingproject.com](http://www.thebanmappingproject.com/), with additions, copyright © Theban Mapping Project)

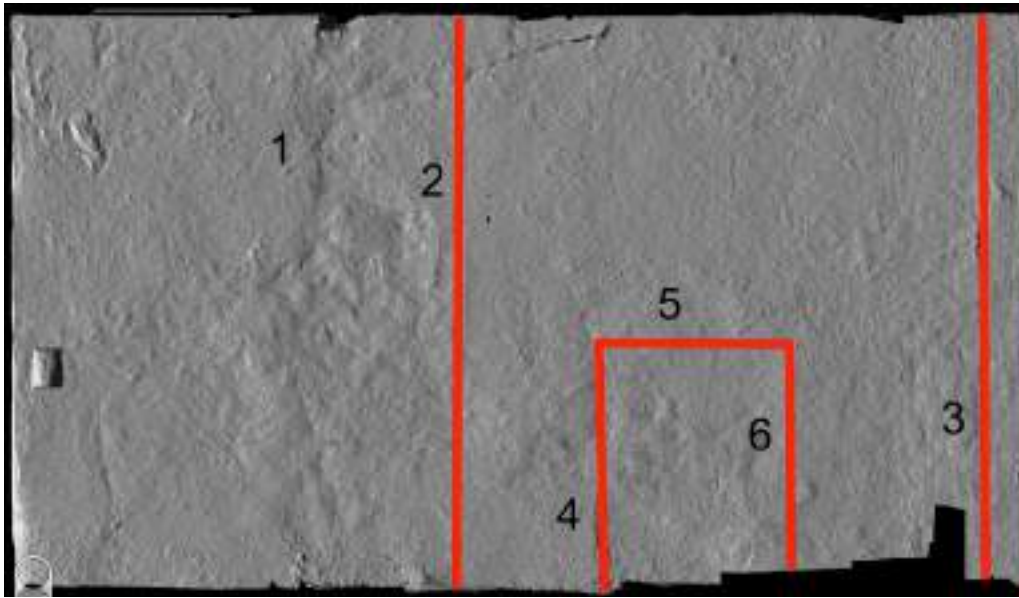

Fig. 20. Burial Chamber (J), KV 62: north wall, surface relief (positive), showing numbered features, partition wall traces and internal door-frame, in red (<http://www.highres.factum-arte.org/Tutankhamun/>, with additions, copyright © Factum Arte/Ministry of State for Antiquities and Heritage, Egypt)



Fig. 21. Antechamber (I), KV 62: north wall partition and its internal sealed doorway (shown partially dismantled) giving access to the Burial Chamber (J) (Carter MSS, Burton photo p0293, copyright © Griffith Institute, Oxford)

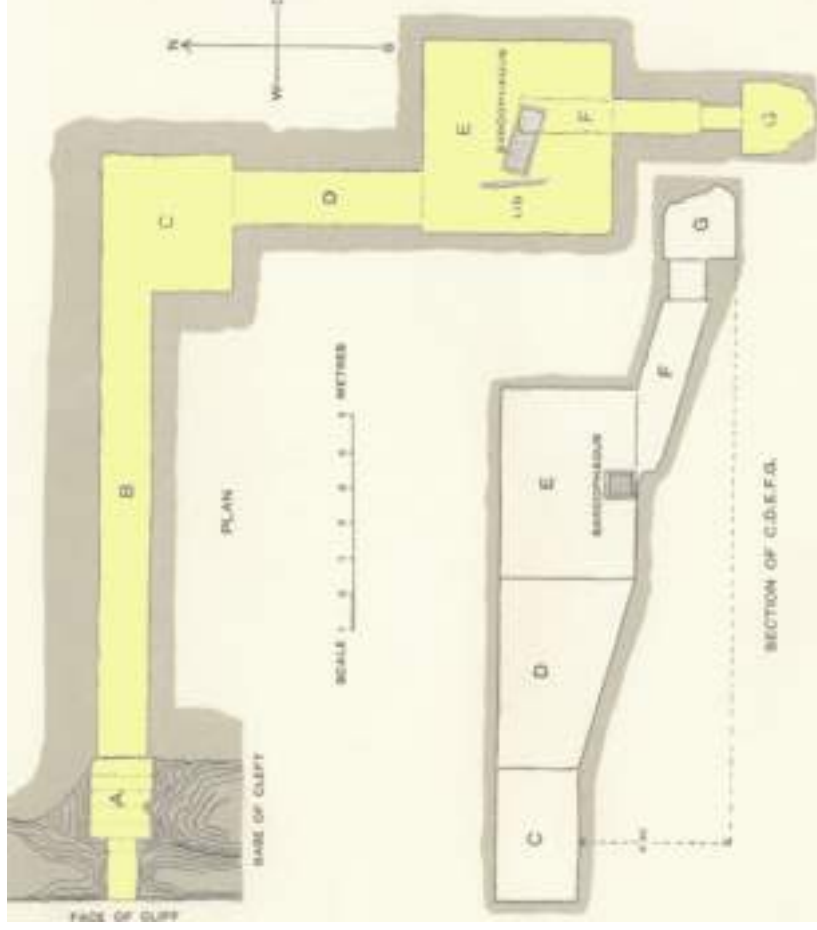

Fig. 22. The right-turning, L-shaped core of KV 62 (left) compared with the right-turning, L-shaped plan of WA D prepared for Hatshepsut as principal consort of Thutmose II (Right: original plan after Carter 1917, Pl. XXI, with emendations and additions, copyright © Egypt Exploration Society)

(Left: Weeks 2003, sheet 69/70 / <http://www.thebanmappingproject.com/>, with emendations and additions, copyright © Theban Mapping Project.

	North wall	South wall	East wall	West wall
Paint layers	a	Upper paint layers	Upper paint layers	Upper paint layers
	b	Yellow background painted around the figures (~0.01-0.06 mm)	Yellow background (~0.01-0.03 mm)	Yellow background (~0.01-0.03 mm)
Ground layer	c	White ground layer (~0.01-0.03 mm)	Layer not present	White ground layer (~0.005-0.02 mm)
	d <sub>1</sub>	Layer not present	Fine buff plaster applied as a wash (~0.02-0.1 mm)	Fine buff plaster applied as a wash (~0.06-0.09 mm)
Preparatory layers	e	Fine gray plaster applied as a wash (~0.1-0.7 mm)	Layer not present	Layer not present
	f <sub>1</sub>	Layer not present	Coarse gray plaster (~0.5-1.5 mm)	Coarse gray plaster (thickness unknown)
Plaster layers	d <sub>2</sub>	Fine buff plaster (~1-3 mm)	Fine buff plaster (~0.1-2 mm)	Fine buff plaster (~1-1.5 mm)
	f <sub>2</sub>	Coarse gray plaster (thickness unknown)	Layer not present	Coarse gray plaster (thickness unknown)
	g	Coarse brown plaster (thickness unknown)	Coarse brown plaster (thickness unknown)	Coarse brown plaster (thickness unknown)
Support	h	Limestone	Limestone	Limestone

\*d<sub>1</sub>, d<sub>2</sub>, and f<sub>1</sub>, f<sub>2</sub> indicate plasters of the same composition that can occur twice within the stratigraphy of a wall. Not every area will necessarily have both layers.

Fig. 23. Stratigraphy of the Burial Chamber (I) walls, KV 62, as established by the Getty Conservation Institute, from the uppermost painted surface through to the limestone support  
(After Wong et al. 2012, S326, Fig. 5, copyright © Getty Conservation Institute)

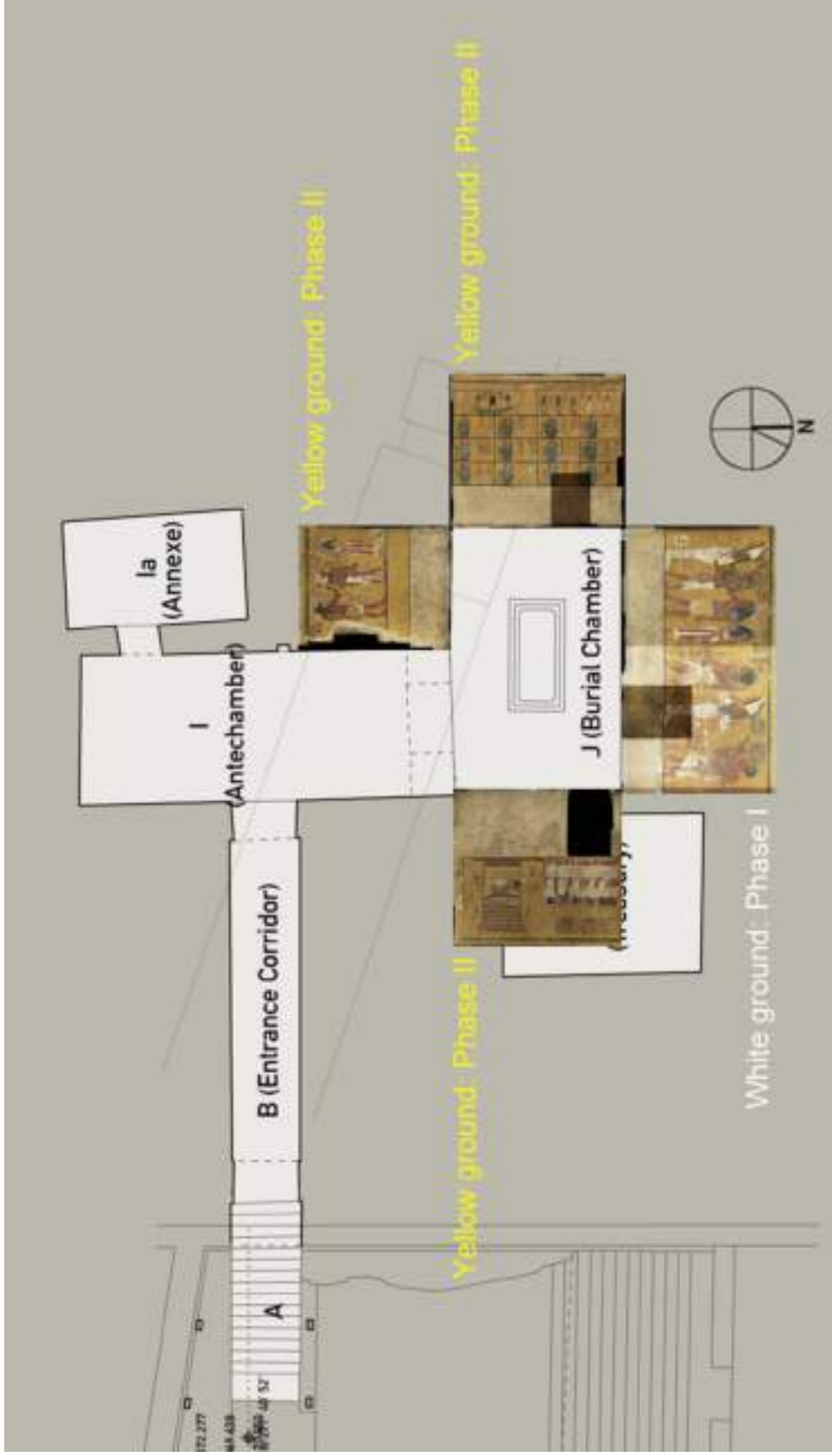

Fig. 24. Plan of KV 62, showing the two phases (I – white ground; II – yellow ground) of the Burial Chamber (J) decoration (Weeks 2003, sheet 69/70 / <http://www.thebanmappingproject.com/>, copyright © Theban Mapping Project, with emendations and superimposed images from <http://www.higehres.factum-arte.org/Tutankhamun/>, copyright © Factum Arte/Ministry of State for Antiquities and Heritage, Egypt)



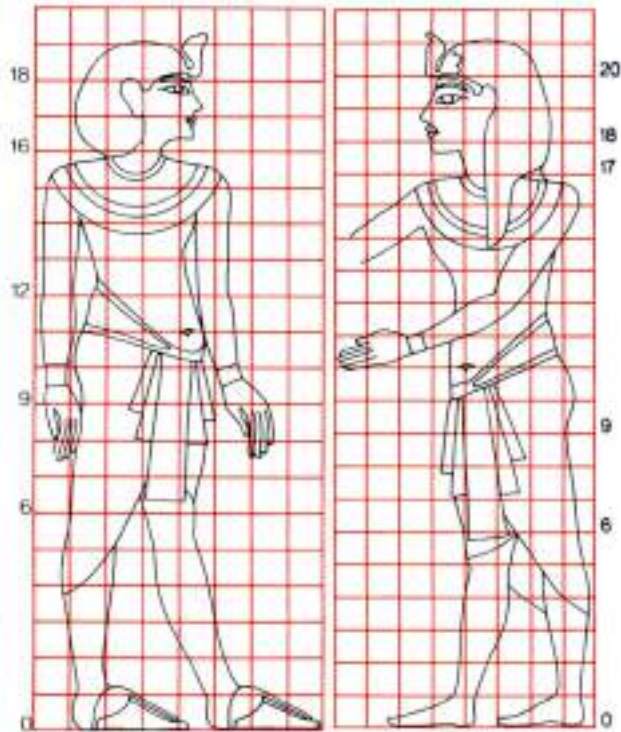

Fig. 25. The two proportional scales encountered in the decoration of the Burial Chamber (J), KV 62: (left) south wall – post-Amarna 18-square grid (associated with Phase II); (right) north wall – Amarna 20-square grid (associated with Phase I)

(After Reeves 1990b, 74, based upon Robins 1984, Figs. 1 and 2, copyright © Gay Robins)



Fig. 26. KV 57 (Horemheb): Remains of decorated scene which originally concealed access to the tomb beyond the “well” (E)

(Photo Francis Dzikowski, [http://www.thebanmappingproject.com/sites/browse\\_tombimages\\_871\\_200.html](http://www.thebanmappingproject.com/sites/browse_tombimages_871_200.html), no. 16139, copyright © Theban Mapping Project)



Fig. 27. The face of the Osirid king on the north wall of the Burial Chamber (J), KV 62, compared with the face of the so-called “aged Nefertiti” to illustrate shared lines of brow and nose, straight jawline, small, rounded chin, and deep “oromental groove”

(Left: <http://www.highres.factum-arte.org/Tutankhamun/>, detail, copyright © Factum Arte/Ministry of State for Antiquities and Heritage, Egypt. Right: Berlin 21263, detail, reversed, copyright © Ägyptisches Museum, Berlin)



Fig. 28. The face of the ministering sem-priest (“Ay”) on the north wall of the Burial Chamber (J), KV 62, showing the same plumpness and under-grooved chin as an early image of the young Tutankhamun from KV 62

(Left: <http://www.highres.factum-arte.org/Tutankhamun/>, detail, copyright © Factum Arte/Ministry of State for Antiquities and Heritage, Egypt. Right: Carter MSS, no. 008, Burton photograph p1880, detail, reversed, copyright © Griffith Institute, Oxford)



Fig. 29. Burial Chamber (J), KV 62: reconstruction of north wall scene on its original white background (Phase I), showing original identifications (<http://www.highres.factum-arte.org/Tutankhamun/>, with emendations and additions, copyright © Factum Arte/Ministry of State for Antiquities and Heritage, Egypt)

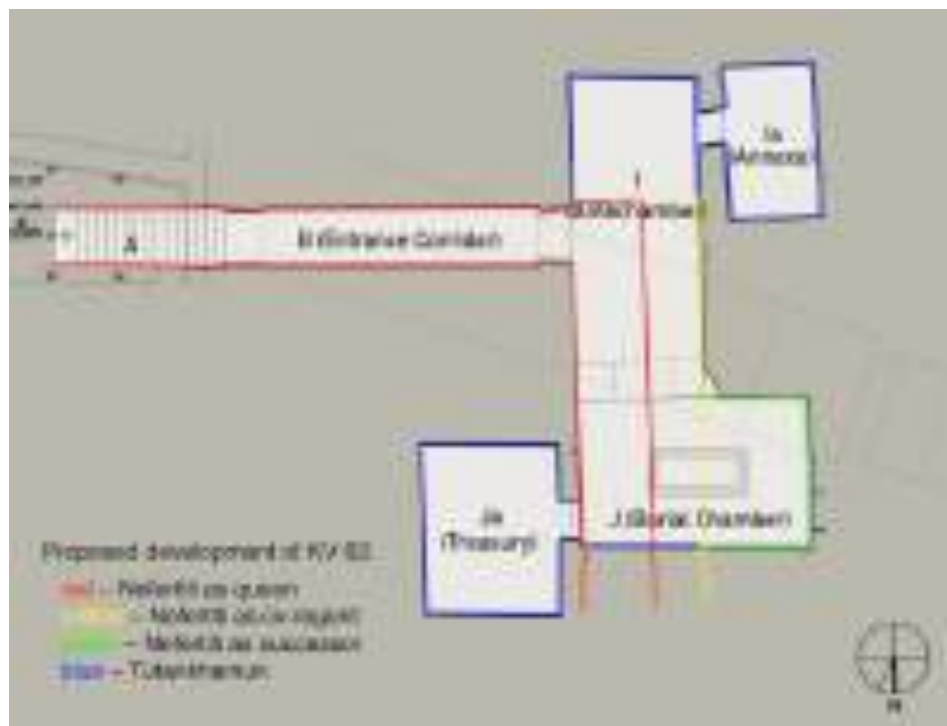

Fig. 30. Suggested development of KV 62, from its inception as the tomb for a queen to the ultimate occupation of its outermost chambers by Tutankhamun (Weeks 2003, sheet 69/70 / <http://www.thebanmappingproject.com/>, with emendations and additions, copyright © Theban Mapping Project)