



THE RAMP AT HATNUB QUARRY: NO SOLUTION FOR PYRAMIDS

Stephen Brichieri-Colombi

E-Mail: stephen.synaquanon@gmail.com

Brichieri-Colombi, Stephen. The Ramp at Hatnub Quarry: No Solution for Pyramids. – Palarch's Journal of Archaeology of Egypt/Egyptology 16(1) (2019), 1-21. ISSN 1567-214X. 21 pages + 10 figures, 5 tables.

Keywords: Hatnub, Ramp, Pyramid construction

ABSTRACT

Certain features of the ramp first uncovered by the IFAO/University of Liverpool team in 2015 at the Old Kingdom alabaster quarry at Hatnub have been heralded as a model for ramps used in construction of the Great Pyramid of Giza. These features include a steep slope of up 20% (11°), inclined stairways on both sides and post holes at regular intervals. The archaeologists hypothesize that these features allowed the haul team to be split into two groups, one hauling upslope with a direct pull, and the other downslope on ropes passed around the posts “acting as pulleys”, thus enabling a steep slope to be used. This paper is based on the physics of various arrangements and demonstrates that the hypothesis is untenable as the posts would have acted as bollards and provided no mechanical advantage. The posts were necessary because of the problems large haul teams would have had negotiating the curvature of the ramp. Interesting as the features at Hatnub are, they are unnecessary and undesirable on the ramps that would have been required for pyramid construction, and the hypothesis should be rejected.

INTRODUCTION: DISCOVERY OF THE RAMP

On 30th October, 2018, Dr. Mustafa Waziry, the Secretary-General of the Supreme Council of Antiquities, announced to the Luxor Times that the joint mission of IFAO and University of Liverpool had discovered the way ancient Egyptians used to move stone blocks from the alabaster quarries of Hatnub during the reign of King Khufu (Cheops). In fact, the system had been found by chance in 2015 while archaeologists from the same institutions were studying inscriptions that date from the reign of Khufu, and which had been written up the previous year (Gourdon, 2017). It had been further excavated in 2018, prior to the announcement.

As might be expected, this announcement was widely disseminated in the world's press, and the authors added many details in their interviews with journalists. Under the heading "Ancient ramp shows how pyramids rose from the sand", the London Times of 6 November 2018 published an article which stated that the ramp was 3 m wide, has a slope of 20%, inclined steps on both sides, and a regular pattern of postholes on each side for posts up to 0.5 m in diameter (Whipple, 2018). It did not mention that the ramp was curved.

The article stated that Dr. Roland Enmarch, of the University of Liverpool and Dr. Yannis Gourdon, from the French Institute for Oriental Archaeology, claimed to have found evidence of a surprisingly sophisticated mechanism that they believe was used to construct the only surviving Wonder of the World – a reference to the Great Pyramid of Giza. They made the following points through texts and photographs:

- The ramp was inclined at double the angle that most people would have been considered possible, given the weight of the stones that had to be lifted up it;
- The ramp would have offered two ways of hauling stones: pulling from above, and using the posts as pulleys to haul from below, an arrangement allows people to be spaced up and down the ramp, and all the force to be exerted in the same direction;
- The ropes attached to the sled acted as a "force multiplier," making it easier to pull the sled up the ramp;
- The system doubled the number of people who can haul on the blocks and meant that ramps would have been more compact;
- The stones lifted from the quarry would have weighed several tonnes and been roughly the same size as those used in building the Great Pyramid and therefore, it was a significant finding;
- At the time the Great Pyramid of Giza was being built, this technology was being used to transport huge stones on steep slopes;
- It was both reasonable and a "plausible inference" to assume that this "double lashing system" would have been deployed at Giza although they could not prove it.

The graphic attached to the article includes features that go beyond the statements made by the archaeologists, such as:

- A slope which "grew with the pyramid";
- Posts that extended several metres into the ground;
- A huge block being hauled up by a team of only 22 men.

This was a rather bold claim with none of the caveats archaeologists normally attach to their finds prior to a thorough analysis. Commenting on this story, Kara Cooney professor of Egyptian art and architecture at the University of California, said "It's difficult to tell the significance of this discovery since the archaeologists haven't yet published their research on it. It's a stretch to take an alabaster quarry and say this is how the pyramids were built, because the pyramids weren't built out of alabaster." This comment rather misses the point, in that what matters is the mass of the blocks to be moved rather than the material of which they are made,

and the fact that pyramids are built above, rather than below, ground level. She is, nevertheless, right about it being a bit of a stretch: the discovery of the ramp was extremely interesting, but there is no justification for the assertion that the ramps used on the Great Pyramid were of similar design. In fact, the research had been published without fanfare in the IFAO Bulletin, where Gourdon included an interpretation of his findings previously that corresponded with that announced in 2018, including the use of split teams pulling both upslope and downslope. In his conclusions (Gourdon, 2017: 250) he made the statement that: “*Le système que nous avons ainsi mis en évidence pourrait avoir d’importantes implications dans notre connaissance de l’architecture égyptienne et notamment en ce qui concerne la construction des pyramides.*” [The system we have revealed could have important implications for our knowledge of Egyptian architecture, particularly in relation to the construction of the pyramids].

In the analysis which follows, reference is made to previous publications by the author (Brichieri-Colombi, 2015a, b) in which detailed assessments were made of the biometric and engineering factors that govern the design and use of ramps. The findings are used here, but the analysis on which these findings are based is not.

QUARRY FEATURES

Hatnub Quarry P is located at 27° 33.3' N 31° 1.3' E, in the Eastern Desert, 14 km from the Nile, between Minya and Assiut. It was originally explored by Egyptologists Newberry and Carter in 1891, and later described by Petrie (1894: 3) as “an open circular pit with vertical sides, about 200 feet [60m] across and 50 feet [15m] deep” (Shaw, 1986: 190). The survey by Shaw in 1985 includes a map based on one prepared by Timme (1970) in 1911, which shows the quarry to be a little larger but provides no additional information on its depth. Shaw (1986: 191) suggests that it was originally a subterranean construction, and that the roof fell in at an early stage of use. Harrell (2009) describes the site as a travertine cave deposit, originally underground, which later became an open-cut working. Neither author provides greater detail.

Gourdon (2017: 243) includes an analysis of the geology of the quarry by Olivier Lavigne, a stone working specialist, who commented on the fact that the upper strata was of poor quality rock with many vertical fissures, and concluded that the quarry could not have been subterranean. Unfortunately, Lavigne provides no further details of strata thicknesses or other geological characteristics. However, many barrel-vaulted structures which incorporate vertical joints demonstrate the ability of jointed rock arches to span considerable widths. For a detailed technical analysis, see Suchowerska *et al.*, (2014).

From the many inscriptions found on the walls of Hatnub Quarry P, Shaw (1986: 201) notes that the earliest occupation of the quarry was in the time of Khufu (2550 BC) and that the “absence of texts from the New Kingdom and later indicates that quarrying must have shifted to other locations in the vicinity at the end of the Middle Kingdom (1640 BC)”. The most recent findings (Gordon, 2015: 246) include nine inscriptions from the reign of Pepi I (2289 BC) to Merenre I (2246 BC). This gives a maximum span of 900 years, but there may well have been periods within this time span when it was not used.

The stone extracted from this quarry is calcite, a crystalline form of calcium carbonate, which is a relatively soft stone with a density of 2.7 t/m³, variously known as Egyptian alabaster or travertine, but referred to in this article simply as alabaster. It was widely used in ancient Egypt for the making of stone pots, and according to Lucas (1962: 421), one in every six pots dating from that time was made of this material. It was also used for a number of sarcophagi and in some large statues, most notably the 2.4 m high statue of Khufu’s successor, Mankare, that now

stands in the Boston Museum of Fine Arts (Accession Number 09.204). The statue was carved from one block that would have weighed, at a minimum, 6.5 t, but if it had been roughed out in the quarry, this would have been reduced by 40% to 3.8 t. It is not known if this statue came from Hatnub, but the 12th dynasty *Inscriptions of Thuthotep* (aka Djehutihotep) record that a block 6.7 m high was transported from there for a colossal statue of him (Breasted, 1906: §688-706). This statue was estimated to weigh 58 t by Lehner (1997: 203) and 70 ± 5 t by Ayrinhac (2016: 470). The two statues (Mankure and Thuthotep) are very similar, both showing a seated figure in a similar posture, and the views in profile show that the proportions were similar. A careful analysis by the author produced a weight of 73 t which corresponds well with Ayrinhac's figure. This weight is very similar to the estimated 75 t of the largest granite beam in the Great Pyramid (Brichieri-Colombi, 2015a: 1284).

This is an important finding, not made explicit by Gordon: if the ramp at Hatnub had only been for hauling small loads, there would be no reason to suggest that it shed light on ramps for the Great Pyramid. But the fact that the evidence suggests that a block almost equal in weight to the largest block on the Great Pyramid was hauled up does indeed introduce the possibility that there are lessons to be learned from the design of the ramp at Hatnub.

ACCESS RAMP

It is uncertain how steep the ramp was in Old Kingdom times, as the floor may have been lowered over its lifetime. The alabaster has been mined rather than quarried from the surface, although there must have been some visual evidence at the surface or in a cave to indicate its presence underground. Gourdon and Enmarch reported on the website of the Egypt Exploration Society (<https://www.ees.ac.uk/hatnub>) that, in their search for further unpublished inscriptions, a 6.6 m trench was opened against the south wall of the quarry. They state that the natural floor of the quarry was reached at 2 m depth, but give no details of the upper and lower levels of the alabaster stratum.

The plan dimensions of the quarry as measured by different authors (and by the same author in different publications) vary significantly. The measurements adopted here are based on high resolution satellite imagery (Gourdon, 2014), which does not show a scale. In figure 1 the image has been reoriented to north and scaled using common features on a Google Earth image. As shown, the quarry can be represented by a 72 m by 24 m ellipse, which has an area of 2,400 m².

Petrie (1894: 3) noted that the depth was around 50 feet (15 m) and this is confirmed by Gourdon who states it is 15 m deep. This is confirmed by Gourdon (2014b) who states it is "*profond d'une quinzaine de metres*" (15 m or so deep). This is consistent with his reference in the London Times (Whipple, 2018) to a slope of up to 20% on an 80 m ramp, and with the posture of a man in a photo who is standing on the ramp. It is unclear in the image how far the ramp extends into the quarry, but there is no reason to dispute Gourdon's estimated length.

A photo (figure 2) accompanying the discovery shows a ranging pole laid across the width of the ramp, from which it can be estimated that, at that point, the stairs are 2.2 m wide on the west and 1.2 m on the east, and the smooth area between them 4.4 m, for a total overall width of 7.8 m. This is consistent both with reported measurements and with those scaled from the image. The lower part of the ramp has not yet been excavated, and for the purposes of this paper it is assumed that the smooth part is 4.4 m wide throughout.

The geometry of the ramp is shown in figure 3, together with the team dimensions (discussed later) in order to show the relative sizes. The ramp centreline can be represented by the trace shown on the figure, which includes a 24 m long arc

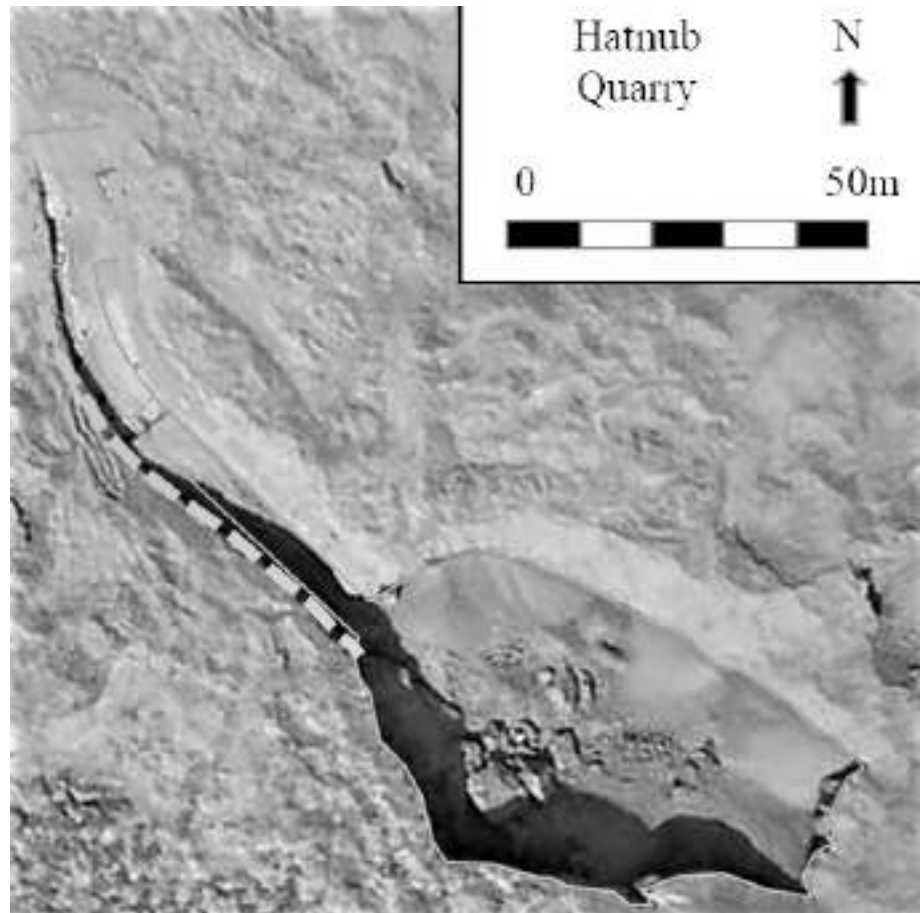

Figure 1. Satellite image of Hatnub Quarry. Downloaded 31 October 2018 from: <https://mediterraneoantico.it>.



Figure 2. View on the ramp. Photo courtesy of Yannis Gourdon/French Institute for Oriental Archaeology.

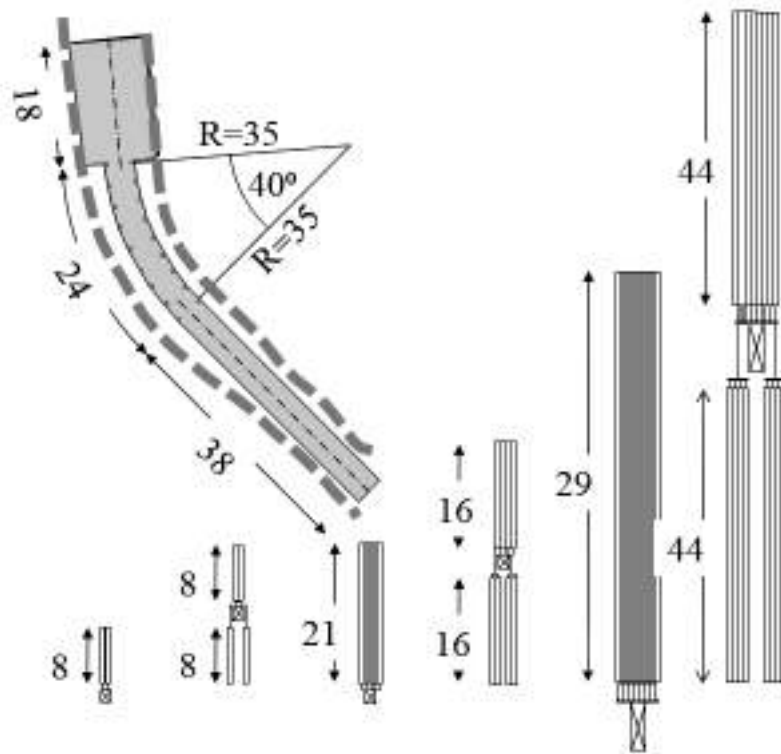

Figure 3. Geometry of ramp and teams. Copyright S. Brichieri-Colombi.

turning through 40° on a radius of 35 m, and a width that varies from 6 to 9 m. We can only speculate about the reasons the ramp is curved. It is most likely that the seam of alabaster that cropped out on the surface led the quarry workers in one direction, but the continuation of the seam led them in another, and rather than re-excavate, they simply followed the seam. This would not have mattered when only small teams were needed to haul out the smaller blocks, but it would when the high quality of the stone led to a demand for much more massive blocks. By then, the work required to excavate to a straight ramp wide enough for a large team would have been huge, and an alternative solution would have had to be found quickly.

LOADS TO BE HAULED

From the photos that accompany the various articles, it appears that the upper level of the alabaster is at about 8 m below the quarry rim, leaving a sub-horizontal stratum 7 m deep. It is credible that initial quarrying operations would have been carried out underground, but the roof would undoubtedly have caved in as the width was increased, as it is now far in excess of the width that could have been self-supporting.

These measurements suggest that the total volume of alabaster was in the order of $16,500 \text{ m}^3$. Some 30 to 50% would have been lost due to mining operations (Lehner, 1997: 206), but almost all of it would have to have been brought up the ramp to the spoil heaps at ground level to permit movement on the quarry floor, and Shaw (1986: 198) notes many huts around the quarry containing Old Kingdom sherds and evidence of working alabaster. In addition, most of the overburden would have been brought up after the collapse of the roof, whether the collapse was controlled or not.

Assuming that the quarry was in active use for at least 200 of the 900 years from the 4th to 14th dynasties, the average rate of excavation of stone would have been around $80 \text{ m}^3/\text{year}$, compared with the maximum rate of placement of material in the Great Pyramid of around $120,000 \text{ m}^3/\text{year}$ (Brichieri-Colombi, 2015a: 2930). It is quite possible that during the period when the quarry was reopened following

the roof collapse, the material that fell into the quarry was removed at a higher than average rate in order to access the alabaster as quickly as possible, but given the limited volume, there is no reason to suppose the excavation rate was anything like the rate at the pyramid.

Clearly, the considerations in the design of the pyramid ramp related to its transport capacity would not have applied to the quarry ramp: rather, the design would have been based on the maximum load to be transported.

LOAD CHARACTERISTICS

The overburden to be removed would have been in the form of relatively small pieces of broken rock and this, together with the chippings from any rough shaping work carried out in the quarry, would have been brought up on small sleds, or in wicker baskets carried by men or draft animals.

Most of the alabaster pots were relatively small, and could have been carried up the same way, especially if they had been roughed out in the quarry. Large items, such as sarcophagi and life-size statues, weighed 3 to 4 t, were comparable in size to the average limestone block in the Great Pyramid which weighed between 12 t at the base and 1.5 t at the apex. These would have been brought up on sleds. Exceptionally, blocks intended for colossal statues would have been quarried, as mentioned above. As it is the largest blocks which would have determined the design of the ramp, it is on these that this paper concentrates. If the ramp had been incapable of allowing the movement of such a large block, it could not have been suitable for the construction of the Great Pyramid.

RAMP SLOPE

In a quarry, as with pyramid building, there are both losses and gains in increasing the slope of an access ramp. On a pyramid, a steeper slope reduces the material that is needed for the construction of the ramp, and on a quarry, the amount of excavation needed. With sloping sides, the additional volume is proportional to the square of the slope; with vertical sides, closer to the cube. In both cases, it is possible – and likely – that the sides were quasi-vertical. Against this, *pari passu*, the team size that is needed to haul material along the ramp increases, and depends on the maximum load and the coefficient of friction between the sliding parts – the sled on the surface of the ramp – as reduced by the lubricant used, if any. The minimum likely coefficient of friction for a wooden sled runner on a transverse wooden sleeper laid across a ramp, when lubricated, would have been 0.25 (Ayrinhac, 2016: 468; Bricchieri-Colombi, 2015b: 6).

Steep ramps can be dangerous. If the slope exceeds the value of friction – in this case, 1 in 4 – the load will slip backwards down the ramp unless it is restrained. Dynamic friction is usually less than static friction, so once a sled starts moving down the slope, it will accelerate. The risk of a 73 t load moving fast in a confined space would have been something to avoid, especially if half the haul team were downslope of the sled. The slope at Hatnub approaches but does not exceed this slope, at least in the part so far excavated.

Apart from the saving on volumes excavated or constructed, in regions of flat topography, there are no benefits in making ramps shorter rather than longer. In the case of the Hatnub Quarry, the ramp could have been greatly extended on roughly level ground almost indefinitely until it merged with the ancient road to El-Amarna, with no lower limit on slope. On the Great Pyramid, it could have been extended southwards until it reached the line of Khafre's causeway before it encountered falling ground in the quarry area, at which point the minimum slope required to haul a load of 73 t up to the Kings Chamber roof was 17%.

If we ignore the dynamics of haulers' limb movements, which are only important when walking fast or running (Giovanelli *et al.*, 2016) it can be shown that the energy required to lift a load from one elevation to another is at a minimum with a straight ramp, rather than any combination of flats and slopes. It is clear from this ramp that the ancient Egyptians were prepared to use steep slopes when it suited them, and that any pre-conceived notion that slopes could not have exceeded 10% must be discarded. Indeed, Hassan (1942: 76) shows an inscription from the De-beheni Mastaba at Giza, dating to the early 5th Dynasty, depicting a ramp with a gradient of 50%.

TEAM SIZE

The *Inscriptions of Thuthotep* make no mention of draft animals being used in the transport of his statue: rather, they emphasize the size of the gangs of workers used. Although Bloxam (2003: 245) suggests that this might have been for the purposes of self-aggrandisement, there is in fact no evidence to contradict the inscriptions and, as she points out, depictions of draft animals are rare. It is therefore reasonable to assume that hauls were made by teams of men.

In previous work (Brichieri-Colombi, 2015a: 1418-1436), the author estimated team sizes for hauls from a variety of sources, including the stature of workers' bones found in the Giza cemeteries, and conducted numerous experiments designed to measure friction coefficients and the sustained human effort possible in various pulling and hauling activities. This work concluded that a hauler could maintain a pull of 44 kg per man without slipping, and require a minimum space of 0.80 m laterally and 0.65 m longitudinally. With a friction coefficient of 0.25 and a ramp slope of 20%, and after making allowance for the weight of the sled and ropes, team characteristics for the weight of three sizes of load are as shown in table 1.

The team size of 760 men for the large load is consistent with Shaw (1986: 200) who notes that graffito four, dating from the time of Pepi, refers to an expedition of 1000 people; and graffiti six and nine, dating from the First Intermediate Period, both refer to expeditions of 1600 people. These figures would have included the necessary logistical support. Interestingly, the reference is to people rather than men, so the possibility that haul teams could include women, and therefore be larger, should not be excluded. In this paper, the team sizes are based on the assumption that all-male teams were used: mixed teams would have had to have been larger.

The smaller teams would have had no problem hauling on the El-Amara road. Shaw (2013: 527, Fig. 7) shows a photo of a "long dry-stone causeway, 130 m long and 11 m wide, with a maximum height of 2.5 m, was constructed to bridge a shallow wadi", and a longitudinal section (Shaw, 2013: 527, Fig. 8) with a maximum slope of 1:6.5 (15.5%, 8.7°) downhill from east to west. Another longitudinal section of an abandoned road includes a slope of 1:1 (100%, 45°), sloping in the same direction (Shaw, 2013: 525, Fig. 6). Hauls on these slopes would have been downhill, and the haulage problems would have been associated with uncontrolled slippage rather than manpower. The maximum uphill haul slope in Shaw's sections is in Fig. 4, at 1:6 (16.7%, 9.5°). This slope could have been reduced with additional fill, but it appears that the Egyptians did not consider it necessary, and merely maintained the large team needed for the quarry. With eight men abreast, this team would be 6.4 m wide and 75 m long overall (including the sled), and on a causeway 11 m wide would have been able to negotiate curves with a minimum radius of 150 m without the men having to walk on each side of the road.

From this analysis, it can be concluded that the critical location for the haul would have been the ramp up from the quarry floor.

SLED

The ramp is both narrow and curved, and details of the sled need to be taken into account when considering haulage operations. Some evidence for sled use in Old Kingdom times comes from the Chephren Quarry near Toshka. Shaw *et al.* (2008: 293: 312) describes a 1.63 m high loading ramp that surmounts a pair of parallel trenches, each 0.75 m wide and 1.7 m apart, in a bay that appears to be designed for a transport device with a length of 5 m, a height of 1.5 m and an overall width of approximately 5 m (Shaw *et al.*, 2008: 298).¹ The loading ramps appear to be a focus for several trails to the working faces of the quarry, from where individual granite blocks weighing around 4 t may well have been brought on small sleds to be piled on a large sled for onward transport to the Nile, 100 km away, by a large team. The ramps would have enabled 18 such blocks to be piled two high on a sled 3.6 m by 5 m for a total weight of 72 t, almost the same as the large statue and the largest block in the pyramid.

In the Egyptian Museum (Tahrir, Cairo) is a sled that was found at Dahshur and which dates from 1840 BCE (JE 4928; Reisner, 1913: 88-89). It is 4.2 m long and 0.8 m wide, made of two parallel runners approximately 10 cm by 15 cm with four cross members 8 by 15 cm. This sled clearly is intended for large loads. A typical small block would measure 0.9 x 0.9 x 1.15 m, and a medium one 1.5 x 1.5 x 2.0 m. A sled only 2 m long and 0.8 m wide would have been adequate for both small and medium blocks. A large sled would have been able to carry several blocks, and on the pyramid, it would have been easier to use fewer large sleds wherever possible, rather than one sled per block as is commonly supposed² in order to avoid the congestion associated with multiple small teams.

If it had been in the same proportions as Mankau's statue, the block for Thutotep's statue would have measured 6.5 x 3.1 x 2.2 m. Although depicted as being transported vertically – possibly out of respect for the pharaoh – it is far more likely that a block this size would have been transported on its back (figure 4), to provide stability and to avoid having a greater weight on one sled runner than the other. This would have required a sled 7 m long by around 2.8 m wide, but add little to the overall load.

In all cases, the haul ropes were probably passed around the back of the block rather than attached directly to the sled, so that it would be at a convenient height for the haulers.

Allowing for the breaking strain of the vegetable ropes then available, the sled would have been pulled by four 72 mm diameter main haul ropes attached at 1.6 m intervals to a 5 m long yoke placed transversally across the front of the sled. The yoke would have allowed the ropes to be parallel to the sled runners, so achieving maximum efficiency, with haulers in pairs on each side. For the haulers themselves, these would in turn have been attached to smaller yokes with further ropes of around 32 mm diameter, the size preferred by modern tug-of-war teams (for a discussion on this, see Brichieri-Colombi, 2015a).

THE ROLE OF THE STEPS

The provision of steps on either side of the ramp would undoubtedly have been an advantage for a hauler, for the same reason that architects often design inclined steps rather than continuous ramps for pedestrians: it reduces stress in the calf

¹ However, they provide no basis for this latter estimation. From their photograph (Shaw *et al.*, 2008: 309 fig. 4), taken almost directly onto the front face of the loading platform with the trenches clearly visible, the top width can be scaled to approximately 3.6 m. After allowing for a small safety margin each side, the load width on the sled would have been approximately 3 m.

² Load volume $5 \times 3.6 \times 1.5 = 27 \text{ m}^3$. Granite density 2.64. Total load 71.3 m^3 . Unit weight of block 4t. Total number $71.3/4 = 18$. Allow 2 layers 0.75 m deep, 9 per layer. To fit sled, plan dimensions $5/3 = 1.67$ by $3/3 = 1.2$ m, area each layer 2 m^2 .

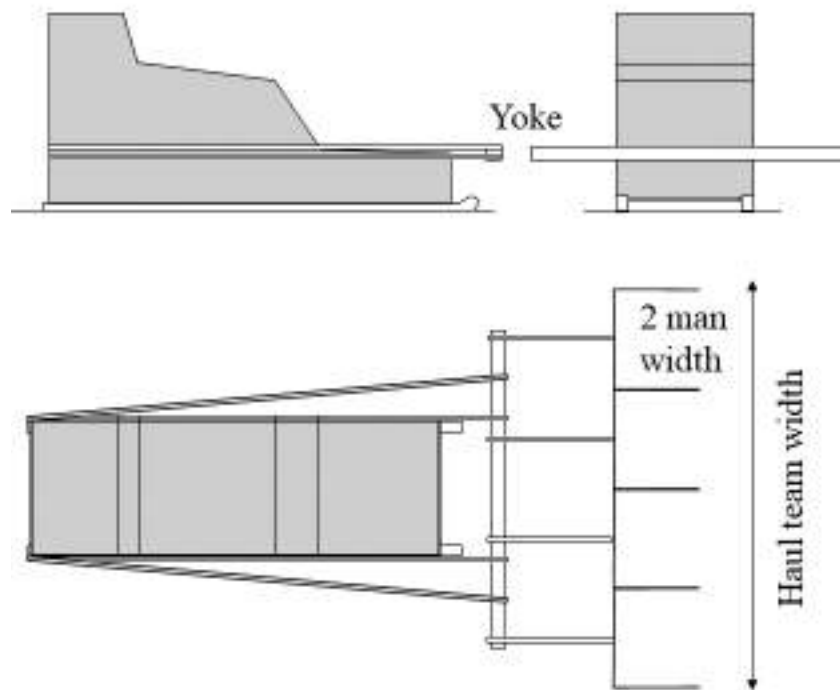

Figure 4. Rough block for Thuthotep's statue. Copyright S. Brichieri-Colombi.

muscles. On slopes above about 15%, it becomes more difficult to exert the required force parallel to the ramp surface.

In 2015, Gourdon provided details of the steps, which show that the step rising and going are 7 and 90 cm respectively, and that the overall slope over ten steps was 18.5%. This means that the going of the steps is at 10.7% to the horizontal, a slope much easier for the ankle to accommodate, whether walking or hauling. As noted above, the steps were not of equal width each side. This is inconsistent with the hypothesis that the steps were provided for haul teams, as they would have been of equal size to allow a balanced pull, and thus, the width of the steps would have been equal. The photos (Gourdon, 2015: 240) show that the steps terminate well before the top of the ramp is reached, at a point that corresponds closely to the top of the curve. The ramp continues further, but also breaks up before reaching ground level, so the features at the top are uncertain. Nevertheless, it is clear that there was a gradual transition between the slope of the ramp and level ground that starts at the top of the steps.

The steps would certainly have been advantageous if the workers had carried-loads on poles or stretchers. The benefits they provided would have been greatly appreciated and would have helped to speed up the work of clearing the debris after the roof collapsed. However, the steps would have been more of hindrance than help if the team were partly on and partly off them, because of the angle it had to adopt. As shown below, in some cases this situation cannot be avoided.

ADJUSTMENTS TO TEAM SIZE

The team sizes tabulated above for a straight haul have to be adjusted to account for losses that arise due to friction on the haul rope as it passes around posts and over supports, and the angle between the direction of haul and the sled runners.

Friction on Posts

When ropes are passed around posts in the way that was suggest by Gourdon (2017: 241), the posts are acting as bollard. This is the nautical term for a strong

vertical post of timber or iron fixed into the ground or the deck of a ship and used for mooring ships. The high friction losses enable dockers to apply braking forces to the vessel being moored, as the force the docker has to apply to the rope to restrain the vessel is very much less than the force the rope from the vessel applies to the bollard. A similar phenomenon applies when capstans (vertical spindles which rotate with ropes around them) are used.

The ratio of the two forces, r , can be estimated using the so-called ‘capstan equation’ developed in the 18th century by Euler and Eytelwein (1824) which relates it to μ , the coefficient of friction between the rope and the bollard, and θ the angle (in radians) of the angle turned by the rope around the capstan. The equation is simple, *viz.*:

$$r = e^{\mu\theta}$$

Interestingly, the formula shows that r is independent of the radius of curvature of the post. Recently, the validity of this formula has been questioned, particularly in its application to elastic knitting yarns, but many can testify to the prediction of the original formula. It fully explains how dockers can hold large ships to wharves with a few turns of a rope around a bollard.

Note that when the rope passes around several posts on a curve the total loss is the loss at each post, multiplied together, not added together. The loss is calculated by adding the absolute values of the angles together before using the equation, irrespective of whether the angles are clockwise, anticlockwise or (in the case of threading) a mix of the two.

In the case of Hatnub quarry, there are three places where rope friction losses will potentially occur (table 2). To counteract the effect of rope friction, minimum team sizes have to be increased wherever it occurs. The situation will change according to the size of the load to be hauled.

Downslope Hauls

Table 2 shows that the number of downslope haulers would have to be increased by a factor of 2.19 to be equivalent to the same number of upslope haulers, suggesting an increase of almost 60%. If, however, a 50:50 split were maintained, the upslope team would be increased as well, and the resulting increase only 37%.

Alignment of Haul

To be fully efficient, the direction of haul needs to be kept parallel to the direction of motion of the sled. When the haul rope is splayed outwards (or inwards) by an angle θ (figure 5) the force the haul team applies in the direction of motion is reduced by the value of $\cos(\theta)$. If θ is 20° , this value is 0.94; if 40° , it falls to 0.67. If the haul angles on each side were not equal, the team with the larger angle would have had to pull harder than the other one.

A parallel pull (with $\theta = 0^\circ$) can be achieved by attaching the haul ropes to a yoke with a length a little over the width of the haul team, and fixed transversally across the front of the load with the haul ropes spaced equally along its length. Where the ropes lead to posts on either side of the ramp, the haul angle will inevitably be greater than zero, and the team size has to be increased to compensate.

CHANGE IN DIRECTION

Unless specific provision is made, haul ropes have to be kept straight both vertically and horizontally, as the rope exerts a large inward force at any bend. At the top of the ramp, where it meets level ground, the bend is 11° and the downward force equal to 19.5% of the tension in the rope. If a team of 500 men is hauling at ground level, this force is equal to the pull of 100 men. To resist this force, the rope would have been passed over a horizontal pole or other smooth support at about 0.8 m above ground level, a convenient height for the haulers.

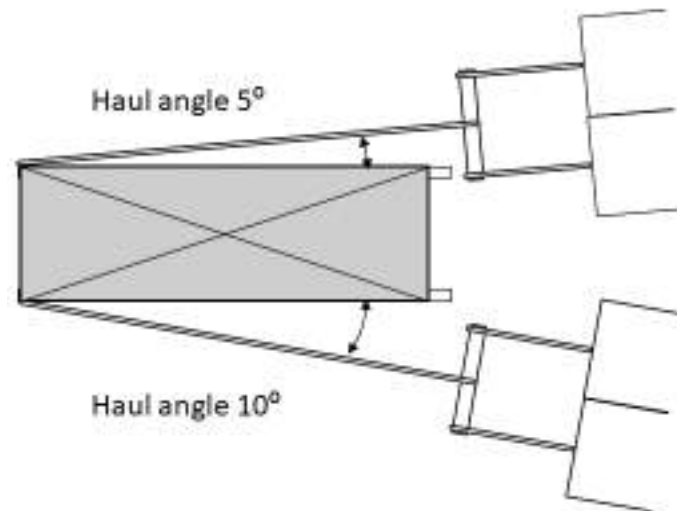

Figure 5. Pull angle. Copyright S. Brichieri-Colombi.

METHOD OF HAUL

On long hauls, teams can haul as they move continuously forward, but in other places, it may be desirable to keep the team almost static. In that case the team can either haul in a series of synchronized short heaves, moving back after each heave to the starting point, or hand-over-hand. In such cases, the main haul ropes have to be shortened at regular intervals. In none of these cases are adjustments to team size required.

OTHER EXAMPLES OF BOLLARDS

In his 2015 article, Gourdon cited Dieter Arnold and Manolis Korres as references providing examples of posts being used in the manner he suggests. Arnold (1991: 89-93) refers to “two round brick pillars” on a ramp 3.85 m wide with a slope of 8° at the 62 m high 12th dynasty pyramid of Sensworet I at Lisht, and illustrates them in an isometric view which shows the clear width between the pillars was c. 6.35 m. With no further evidence or argument, he Arnold (1991: 90) states that “They were the foundations for vertical wooden posts which were used to attach the ropes. Similar posts must have been erected at the upper end of the ramp. Unfortunately, it is not known if the arrangement consisted of only these posts or also of a more efficient kind of lifting mechanism.”

Arnold does not make clear why he believes that the posts were associated with hauls up the ramp, or to which ropes he refers, nor is there any evidence for the existence of “similar posts”. The term “lifting mechanism” could refer to the hauling of stone blocks up the ramp, but Arnold does not say this explicitly. In his later book, Arnold backs away from his original suggestion, referring to the posts as pillars and saying only that they “may have been part of some pulling system” (Arnold, 1994: 195).

The largest blocks of the Lisht pyramid weigh 20 t (Lehner, 1997: 171) and, according to the calculations by the present author, would have required a team of 200 men with a width of 3.2 m, easily able to pass between the pillars.

Arnold does not state that the wooden posts would have to be used for downslope haul teams in the manner suggested by Gourdon and Enmarch, and indeed Arnold’s reference to a “more efficient way” suggests that he was aware of the fact that such a method was inefficient. However, his (Arnold, 1991: 282-283) discussion about the use of “bearing stones” suggests that the friction losses which occur when ropes are passed over any curved surface, were not reckoned with. If wooden posts were indeed used at Lisht in the manner suggested, they would not

have been mounted in masonry columns. The haul force of 4.5 t exercised by a 200 man team on each haul rope at a height around a metre above ground level would have induced a bending moment in the pillar and hence tension forces in the masonry far in excess of that which it would have been able to support. A simple post hole in the ground or lower courses of brickwork would have been structurally better. It seems likely that the pillars were designed to support a vertical load, not a near-horizontal one.

Korres (2001: 103) shows the use of both vertical and horizontal posts as bollards on the ramp from Spelia Quarry, one of the penelicon in, 20 km from Athens (Greece) quarries that were used to supply stone for the construction of the Parthenon. Korres makes clear that the posts were used to brake loads being transported down the slipway, not as aids to hauling them up. Bollards are designed for braking, and by their very nature, are ineffective as accelerators or “force multipliers”.

TEAM MANOEUVRES

The manoeuvres different teams, divided into left and right groups, would have had to make to negotiate the curve of the ramp situations are examined below by looking at the movement of the teams and sleds as they are hauled up the ramp, and the various angles of the haul ropes. At the end of this section, table 3 shows the numerical values of pull angles and angles turned around the lateral posts for split teams, while table 4 shows the resulting adjustments to team size. These numbers are not repeated in the following text.

Three load sizes are considered, using either a unified team (all the men pulling upslope) or a split team (half the men hauling upslope, half downslope). In each case, the sled is kept on the smooth part of the ramp. It is assumed that the highest post is level with the top of the curve, and that maximum length available for a team to stand on the slope between there and level ground is 17 m, as measured on the satellite image (figure 1). The remainder of the team would have had to stand on level ground beyond the top of the ramp, increased in size to allow for the losses due to the change in vertical angle.

Small Unified Teams

For small loads, the 24-man teams required would have been divided equally into two groups, one on each staircase. The groups could advance though the four positions shown in figure 6. Using a yoke 6 m long they would have been able to angle themselves to remain parallel to the sled as they hauled it round the curve, always keeping the rope straight and the entire team on the steps.

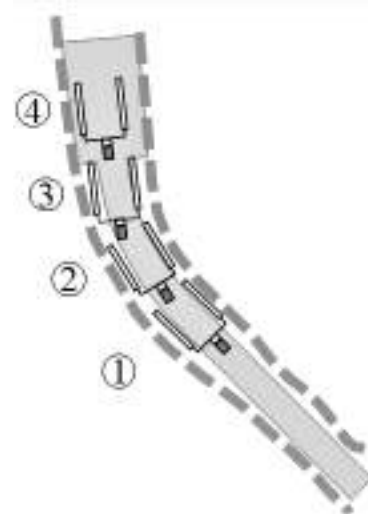

Figure 6. Passage of small unified team. Copyright S. Brichieri-Colombi.

No vertical posts or steps would have been required and therefore no rope friction losses incurred, so the team could have been kept to the minimum size. Vertical posts at the edge of the ramp would have interfered with the passage of the yoke.

Small Split Teams

There would have been no reason to use small split teams, which would have had to be larger than a unified team, with no compensating benefits.

Medium Unified Teams

The 124-man teams required medium loads would have been divided as for small loads, but the groups would have been too long and too wide to be able to remain on the steps, as seen in on the left diagram in figure 7.

To avoid this situation, the team would have started on the smooth part of the lower end of the ramp, and hauled the sled up until the front man of the team met the edge of the steps on the western side. The team would then have rotated a little clockwise and continued onwards until it was unable to go further without the front man crossing onto the steps (upper position in centre diagram). The team would then have moved to the top of the ramp, passing the haul ropes around a series of vertical posts on each edge of the curved part of the ramp, as shown in the right diagram. Note that posts would have been needed each side of the ramp to ensure the sled was drawn between them rather than up against a post. At this point, the angle turned by the rope around the posts would have been at a maximum and the team size correspondingly increased to allow for the various friction losses.

Medium Split Teams

The whole team size would have been increased because of friction around the posts. However, because each half would have been shorter than the unified team, it would have had a length of only 14 m. As each side could have been at different angles to the sled, they would have had the manoeuvrability to navigate the curve, albeit only just.

They would have started as a unified team, getting to the position as shown on the left diagram in figure 8 before having to break into upslope and downslope groups. The upslope group, with all the men standing on the upper ramp, would have been able to maintain a direct haul on the ramp, parallel to the line of motion,

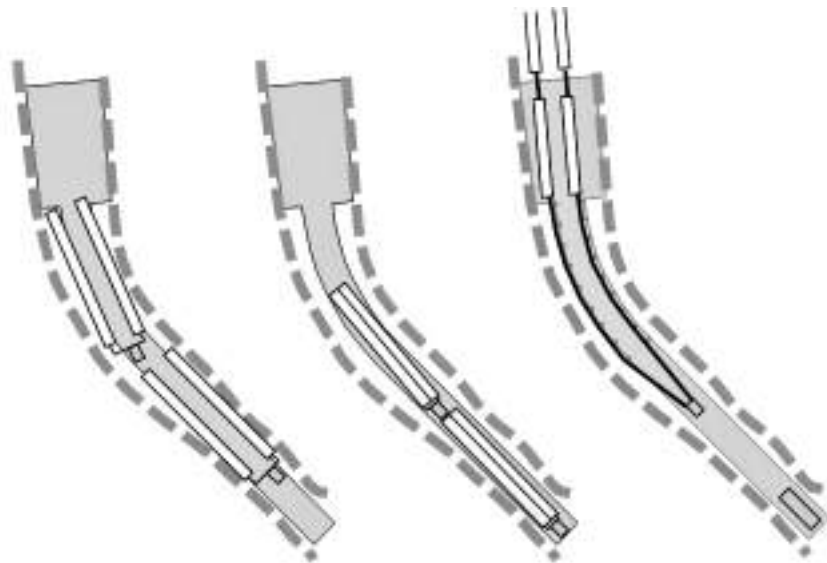

Figure 7. Passage of medium unified team. Copyright S. Brichieri-Colombi.

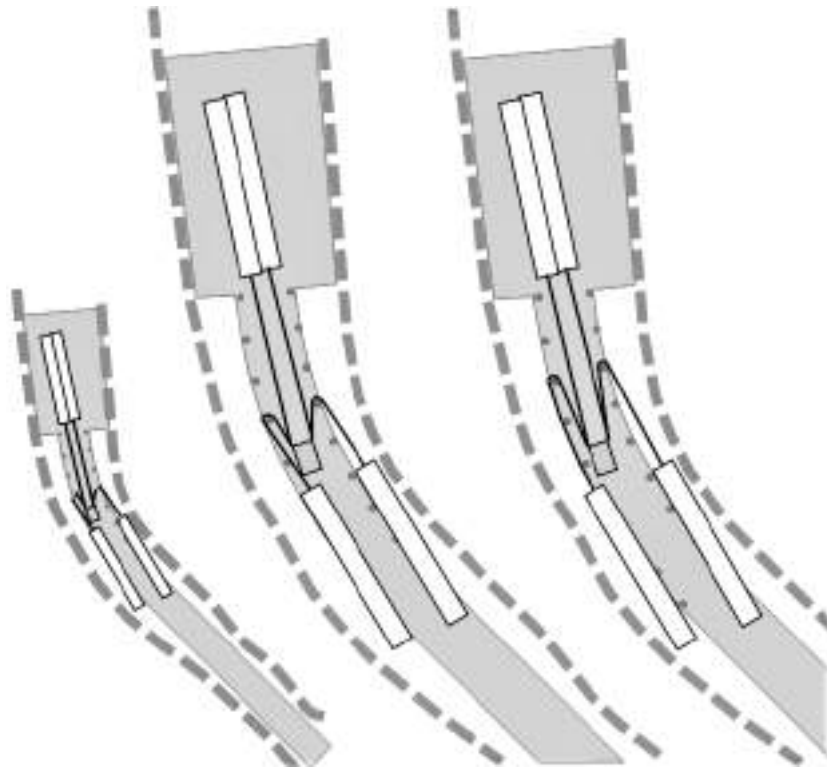

Figure 8. Passage of medium split team. Copyright S. Brichieri-Colombi.

so they would have been fully efficient. However, the downslope teams would have incurred losses due to friction round the posts and the haul angle.

As the sled advanced up the ramp from the position in the centre diagram to that on the right diagram, the friction round the posts would have reduced but the haul angle would have increased until, at some point, the ropes would have been passed around a set of posts higher on the ramp. The angles for the west and east teams would have been different, and changed when they move to the next post, leading to different calculations of team size on each side. In the tables, the average angles of east and west teams for the rope around the upper pair of posts would have had the lowest efficiency, and thus, has accordingly been adopted. The downslope team would not have been able to advance unless the posts had been removed, so the teams probably stayed in one place and hauled hand-over-hand.

Large Unified Teams

There is no way a large team, 62 m long, could have passed round the curve in the ramp (figure 9). Neither could the ramp have been straightened without undertaking the major additional excavation works shown in the centre diagram.

For large loads, only a proportion of the men needed could stand at the top end of the ramp, the rest standing on the ground at the top, and hauling from there. The haul ropes would have been passed around a double line of vertical posts on each side of the ramp as shown in the right diagram to prevent them being damaged as they chafed against the rock sides of the ramp.

Large Split Teams

As with medium teams, the large split team would have had to be enlarged. Each half would be 42 m long, and equally unable to manage the curve (figure 10). After entering the ramp as far as it could as a unified team, the upslope team would position itself at the top of the ramp, with some men on the ramp and the balance on the ground above, while the downslope team would have hauled from below in the position shown, both teams hauling hand-over-hand.

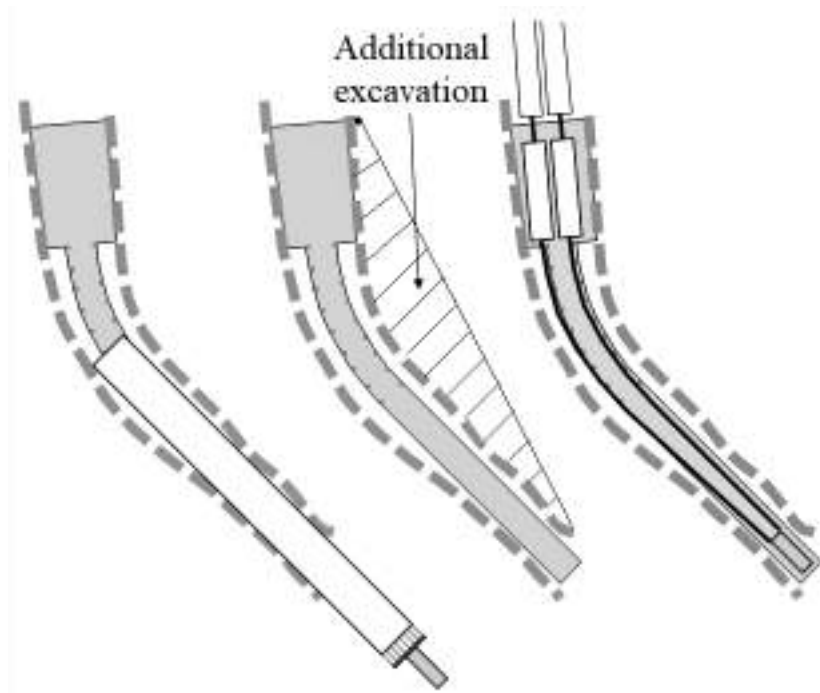

Figure 9. Large team and additional excavation.
Copyright S. Brichieri-Colombi.

Effect of Angles on Team Size

The actual angles, efficiencies and teams sizes for each configuration and key position are tabulated in table 3 and 4. The team size for each of the situations described above is summarized in table 5. In each case the size of a unified team would have been smaller than a split one. Small teams would have been able to remain on the steps in either configuration, and the large unified teams could stand on the slope above the steps, but in the other arrangements, the teams would be partly on the steps, and partly on the smooth section of the ramp. The wooden posts were required for the unified large teams, and all split teams.

It is important to note that the requirement for posts was dictated not by the steepness of the ramp, but by its curvature.

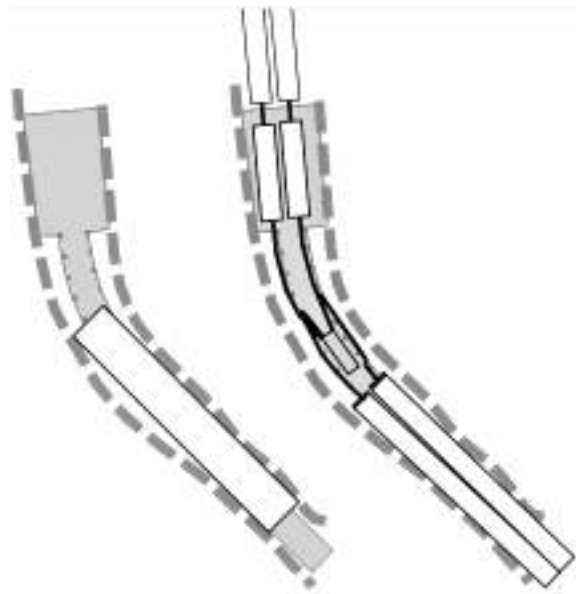

Figure 10. Passage of large split team. Copyright S. Brichieri-Colombi.

IMPLICATIONS FOR PYRAMID BUILDING

Curvature

The hypothesis put forward by the Anglo-French team makes no reference to one of the most important features of the ramp at Hatnub: its curvature. Yet this is the element that would have dominated the situation.

As far as the author is aware, it has never been suggested that curved ramps were used in pyramid building. As the analysis above shows, curvature introduces serious constraints on team movements that can only be overcome by unnecessary and expensive widening of ramps. If a section of spiral ramp had been adopted for the construction of the Great Pyramid, there would have been sharp corners rather than curved sections to negotiate. The problem and manoeuvres to overcome it is discussed elsewhere (Bricheri-Colombi, 2013).

Steps

Where a high rate of haulage on a ramp was needed, as in pyramid building, provision would have had to be made for at least two parallel haulage lanes, and a third lane between them to allow a team to change lanes to overtake another when breakdowns occur. With the low rate of extraction from the Hatnub quarry, this would not have been necessary: the haul would simply have been suspended until repairs were completed.

Changing lanes would not have been easy, and any lateral steps (and posts) on the lanes of a pyramid ramp would have been another obstacle to overcome – not insurmountable, but inconvenient and thus adding delay. Given the marginal advantage they would give, it is unlikely they would have been provided.

Slope

The Times article stated that the ramp was inclined at double the angle that would have been considered possible, implying that the maximum slope was 10%. The discovery makes clear that heavy blocks could be hauled up slopes as steep as 20% even where ramps are curved, but it does not demonstrate that split team haulage systems were in general use.

The heaviest loads in the pyramid weighed 75 t, and were lifted to a level of 60 m above its base. If, as suggested, they were brought up by a straight main ramp on the south side that started on Khufu's causeway, and also used for the limestone blocks weighing up to 12 t, a slope of no more than 1:6 (16.7%) would have been required (Bricheri-Colombi, 2015b: 7). A spiral ramp with straight segments continuing from the intersection of the main ramp with the south side of the pyramid, maintaining the same slope, would reach to within a few metres of the apex. The 1:6 slope on the ramp was necessary and sufficient and, as the Hatnub quarry demonstrates, less than the maximum used in Old Kingdom times.

Posts

The posts would have been needed at Hatnub to enable very large blocks of the size depicted in Thutotep's tomb to be hauled up a curved ramp by a unified team. They could have also been used if split teams were used, but this would lead to increased manpower requirements and conveyed no compensating advantages. There is no justification in assuming that posts were used on straight pyramid ramps.

Great Pyramid Ramp

All the features of the ramp discovered at Hatnub, the slope, stairs, posts and, most importantly the curvature, need to be considered in the analysis of its function, before deductions are made about its relevance to building pyramids, and in par-

ticalar, the Great Pyramid of Giza. When drawing inferences about construction methods, it is wise to ensure that biometric and engineering factors are considered. In short, the split team hypothesis proposed by Gourden and Enmarch for the ramp at Hatnub is untenable either for Hatnub Quarry or for the ramp at the Great Pyramid of Giza.

BIBLIOGRAPHY

- Arnold, D. 1991. *Building in Egypt: Pharaonic Stone Masonry*. - Oxford, Oxford University Press.
- Ayrinhac, S. 2016. Transportation of the Djehutihotep Statue revisited Tribology. - *Online* 11, 3: 466-473.
- Bloxam, E. 2003. *The Organisation, Transportation and Logistics of Hard Stone Quarrying in the Egyptian Old Kingdom: A Comparative Study*. - PhD Thesis, Institute of Archaeology UCL.
- Brichieri-Colombi, J.S.A. 2015a. *Shifting Stones: Building the Great Pyramid*. Kindle edition. At: <https://www.amazon.com/Shifting-Stones-Building-Great-Pyramid-ebook/dp/B00RVYY6L2>
- Brichieri-Colombi, J.S.A. 2015b. Engineering a Feasible Ramp for the Great Pyramid of Giza. - *Palarch's Journal of Archaeology of Egypt/Egyptology* 12, 1: 1-16 (free download: www.palarch.nl).
- Egyptian Exploration Society. 2017. Hatnub: The texts of Quarry P in Their Industrial Landscape Context. At: <https://www.ees.ac.uk/hatnub>. Accessed: 17 August 2017.
- Eytelwein, J.A. 1824. *Grundlehren der höhern Analysis*. - Berlin, Reimer.
- Giuliani, T. 2018. Come sollevavano e spostavano i pesantissimi blocchi di pietra gli antichi Egizi? La risposta è arrivata dalle cave di Hatnub. - *Mediterraneo Antico*, 30 ottobre 2018.
- Giovanelli N., A.L.R. Ortiz, K. Henninger & R. Kram 2016. Energetics of Vertical Kilometer Foot Races; Is Steeper Cheaper? - *Journal of Applied Physiology* 120: 370-375.
- Gourdon, Y. 2014. Les nouvelles inscriptions rupestres de Hatnoub. Une saison de prospection dans la "Carrière P". - *Égypte, Afrique & Orient* 73: 238-246.
- Gourdon, Y. & R. Enmarch. 2015. Some Unpublished Inscriptions from Quarry P at Hatnub. - Rosati G. & M.C. Guidotti M.C. Ed. *ICE Proceedings of the XI International Congress of Egyptologists Florence, Italy 30 August 2015*. - Florence, Florence Archaeological Museum.
- Gourdon Y. 2017. Les Inscription rupestres de Hatnoub in *Rapport d'activité 2015-2016*. - *Supplément au bulletin de l'institut français d'archéologie orientale* 116: 238-250.
- Harrell, J.A. & P. Storemyr. 2009. *Ancient Egyptian quarries - An Illustrated Overview*. - Geological Survey of Norway Special Publication 12: 7-50.
- Korres, M. 2001. *From Pentelicon to the Parthenon*. - Athens, Publishing House Melissa.
- Lehner, M. 1997. *The Complete Pyramids*. London, Thames and Hudson.
- Lucas, A. 1962. *Fourth Edition Revised by J.R.Harris. Ancient Egyptian Materials and Industries*. - London, Edward Arnold Publishers.
- Pettit H. & C. MacDonald. 2018. Is This How Ancient Egyptians Built the Pyramids? - *Daily Mail* 8:03 GMT, 6 November 2018 | Updated 18:08 GMT, 6 November 2018.
- Reisner, G.A. 1913. *Catalogue Général des Antiquités Égyptiennes: Models of Ships and Boats*. - Cairo, L'institut Francais d'archéologie orientale.
- Timme, P. 1970. *Tell el Amarna vor der deutschen Ausgrabung im Jahre 1911*. - Osnabrück, Zeiler.

- Shaw, I. 1986. A Survey at Hatnub. In: B.J. Kemp. Ed. *Amarna Reports III*. - London, Egypt Exploration Society: 189-212.
- Shaw I., E. Bloxam, T. Heldal & P. Storemyr. 2008 Quarrying and Landscape at Gebel el-Asr in the Old and Middle Kingdoms. In: Raffaele F., M. Nuzzolo & I. Incordino. Eds. *Recent Discoveries and Latest Research in Egyptology. Proceedings of the First Neapolitan Congress of Egyptology, Naples*. - Wiesbaden: Harrassowitz: 293-312.
- Shaw, I. 2013. "We went forth to the desert land...": Retracing the Routes between the Nile Valley and the Hatnub Travertine Quarries. In: Förster, F. & H. Riemer. Eds. *Desert Road Archaeology in Ancient Egypt and Beyond*. - Cologne, Heinrich-Barth-Institut (*Africa Praehistorica* 26): 521-532.
- Whipple, T. 2018. Ancient Ramp Shows how Pyramids Rose from the Sand. - *The Times Science Editor* November 6 2018.

Size	Purpose	Load (t)	Haulers (no.)	Abreast (no.)	Team width (m)	Team length (m)
Small	General	2,3	24	2	1,6	7,9
Medium	Sarcophagus	12	124	4	3,2	20,2
Large	Statue	73	760	8	6,4	61,8

Table 1. Minimum haul team size.

Location	Plane	Angle	Efficiency μ
Over poles or quoins at the top of the ramp	Vertical	11°	0,95
Around posts on the curve of the ramp (max)	Horizontal	40°	0,84
Around posts used by downslope haul teams	Horizontal	180°	0,46

Table 2. Losses due to rope friction.

Angles for split teams	Position			
	West 1	East 1	West 2	East 2
Medium loads				
Curve	177	158	185	164
Pull	18	5	10	2
Efficiency	49%	50%	45%	49%
Adopted	47%			
Large loads	West Up	East Up	West Down	East Down
Curve	30	14	173	176
Pull	1	16	4	19
Efficiency	88%	98%	47%	49%
Adopted	93%		48%	

Table 3. Angles and adopted efficiencies.

Team configuration	Unified			Split		
	Small	Medium	Large	Small	Medium	Large
Load						
Men needed on 20% slope	24	124	760	24	124	760
Max men on upper slope	54	108	216	-	108	216
Upslope haul efficiency	100%	84%	84%	100%	100%	93%
Downslope haul efficiency				47%	47%	48%
Men on upper ramp	24	108	216	17	84	216
Men on ground	0	42	724	0	0	334
Men on lower ramp				17	84	550
Actual number of men	24	150	940	34	168	1100

Table 4. Adjustments to team size.

Configuration	Small	Medium	Large
Unified	24	150	940
Split	32	168	1100

Table 5. Summary of team sizes.

Submitted: 22 January 2019

Published: 30 July 2019

© 2019 Brichieri-Colombi. This is an open-access article distributed under the terms of the Creative Commons Attribution License, which permits unrestricted use, distribution, and reproduction in any medium, provided the original author and source are credited.